

PUSHING LIMITS
ADRENALINE
CHALLENGES
FAMILY MUD
PERFORMANCE
WE'RE FARMING
BUILT HUNTING
FOR ADVENTURE
THIS HARD WORK

**WE'RE
BUILT
FOR
THIS**



MAVERICKSPORT



MAVERICKTRAIL



2019 ACCESSORIES, RIDING GEAR & GENUINE PARTS
INTERNATIONAL VERSION

CAN-AM ACCESSORIES: THE PERFECT FIT

ENHANCE & EXTEND YOUR OFF-ROAD EXPERIENCE WITH ACCESSORIES BUILT BY CAN-AM FOR CAN-AM.

Wherever you're going, and whatever you're doing, Can-Am Off-Road accessories can help get you there and get it done – faster and more efficiently. High-quality, innovative accessories that work right, fit right and feel right because they're developed or approved by Can-Am for Can-Am.

QUALITY FIRST.

The best off-road accessories are here for a reason: you. High-performance engineering and hard-fought lessons drive the design of everything we do—from our vehicles to the oil they run on.

RUGGED RELIABILITY.

Why do we guarantee Genuine Can-Am accessories for an entire year? Because we can. Install them yourself or at an authorized dealer and immediately upgrade your off-road vehicle without worry.

STYLE & VISION.

Our designers work on both vehicles and accessories, meaning our accessories lineup performs perfectly and looks as great as the Can-ams they've been designed for.

BRP LIMITED WARRANTY*

FOR NEW PARTS, ACCESSORIES AND RIDING GEAR.

2 YEARS LIMITED WARRANTY**

- GENUINE CAN-AM PARTS & ACCESSORIES INSTALLED BY YOU OR YOUR AUTHORIZED BRP DEALER
- CO-BRANDED PRODUCTS SOLD THROUGH BRP¹
- RIDING GEAR

4 YEARS LIMITED WARRANTY**

- HELMETS

*Use other than which the product is designed for will void the product lifetime warranty. **Applies only to BRP-made products or co-branded products made by accredited BRP partners (Lonestar Racing for Can-Am, DragonFire for Can-Am, S3 for Can-Am, Beard Seats for Can-Am, Baja Designs for Can-Am, etc.). Purchased at an authorized BRP dealership / distributor or on a BRP-authorized online store. Other exclusions may apply, see complete limited warranty or contact your Can-Am off-road authorized dealer. ¹Includes only BRP-approved aftermarket products and products made by currently accredited BRP partners. **Unless otherwise stipulated or required by law. This limited warranty does not apply to factory installed accessories. This limited warranty does not apply on Evinrude parts and accessories. This limited warranty is effective as of March 1st, 2016.

© 2018 Bombardier Recreational Products Inc. (BRP). All rights reserved. ®, ™ and the BRP logo are trademarks of BRP or its affiliates. CARLISLE is a trademark of Carlisle Companies. CHAMUDE and HIPORA are registered trademarks of Kolon Industries, Inc. CLARINO is a trademark of Kuraray Co. Ltd. COOLMAX and THERMOLITE are registered trademarks of INVISTA for durable fabrics. DRIFRELEASE is a registered trademark of Optimer Inc. FOX is a registered trademark of Fox Racing Canada. GARMIN and MONTANA are registered trademarks of Garmin Ltd. iPod is a registered trademark of Apple Inc. KOLPIN, GUN BOOT and IMPACT are registered trademarks of Kolpin Powersports Inc. KYB is a registered trademark of Kayaba. MicroSD is a registered trademark of SD Card Association. Mud Lite XTR and S312 are trademarks of TIP Tires. NEXT G-1 VISTA is a trademark of Next Camo, LLC. NGK is a registered trademark of NGK Spark Plugs, Ltd. PRIMALOFT GOLD and PRIMALOFT BLACK are registered trademarks of Albany International Corp. SUPERWINCH and S SUPERWINCH (design) are registered trademarks of Superwinch LLC. TEFLON, TEFLON HT and KEVLAR are trademarks of E.I. DuPont de Nemours & Co. TWINAIR is a trademark of Twin Air USA. UNI is a trademark of UNIFILTER Inc. VELCRO is a registered trademark of Velcro Industries. WARN is a trademark of Warn Industries Inc. YUASA is a registered trademark of YUASA Batteries Inc. ZILLA and BIGHORN 2.0 are trademarks of Maxxis. SCOTT is a trademark of Scott Sports SA. The following trademarks are the property of their respective owners: BLUETOOTH, CREE, DURO, DWT, HELLA, ITP, KENDA, MOSSY OAK, RAM, SUR LAST, VISION, XPS and YOSHIMURA. DRAGONFIRE is a trademark of KRANSCO. Baja Designs is a registered trademark of Baja Designs Inc. S3 POWERSPORTS is a trademark of S3 Power Sports LLC. Some models depicted herein may include optional equipment. Prices, if shown, are based on Manufacturer Suggested Retail Prices. Dealers may sell for a different price. For Canada & US, taxes are not included. Depending on location, products are distributed by BRP US Inc., Bombardier Recreational Products Inc., BRP European Distribution SA, BRP Finland Oy., BRP Australia Pty Ltd. or BRP Brasil Motorsports LTDA. BRP reserves the right, at any time, to discontinue or change specifications, prices, designs, features, equipment without incurring obligation.

¹Warranty periods may vary per region.

2019

MAVERICK SPORT
MAVERICK TRAIL

ACCESSORIES

8	ROOFS	33	LIGHTS
10	SOFT CABS	38	AUDIO & COMMUNICATION SYSTEMS
11	WINDSHIELDS & MIRRORS	40	ELECTRICAL & ELECTRONIC ACCESSORIES
14	DOORS	44	WINCHES & HITCHES
15	REAR WIND PROTECTION	46	PERFORMANCE
16	SKID PLATES	47	TRACK SYSTEMS
17	BUMPERS & GUARDS	50	PLOWS
26	SEATS	53	TRAILERING
27	CARGO & STORAGE		
31	RACK & HOLDERS		

TIRES & RIMS

53	TIRES & RIMS
----	--------------

SPORTSWEAR & RIDING GEAR

56	CAN-AM SPORTSWEAR	61	COMMUNICATION SYSTEM
58	MUD GEAR	62	GOGGLES / GLOVES / JUNIOR
59	JERSEYS	63	BAGS / SIZING CHART
60	HELMETS		
61	DUST MASKS		

PARTS & MAINTENANCE

64	CAN-AM GENUINE PARTS
70	OILS & MAINTENANCE



GOING GLOBAL

This catalog, global in nature, shares BRP's full parts, accessories and clothing product offering. Some products may not be available in your country, due to different climates, local certifications and/or legal requirements. Contact your BRP dealer for local specifics.

CAN-AMOFFROAD.COM



Explore our interactive online catalog. Instantly explore products, videos, large format images and share with friends!



Check out our videos to learn more about our new innovative riding gear and accessories.



Learn about and purchase XPS oils and lubricants.

Visit instructions.brp.com for BRP accessories instruction sheets.

You will find complete installation instructions, part number lists and service kits for repair and maintenance.





WE'RE BUILT FOR PERFORMANCE

NOTHING SHOULD STAND BETWEEN YOU AND THE HORIZON —READY TO TAKE YOUR MAVERICK SPORT BEYOND FACTORY FRESH?



MAVERICK SPORT



- 8 LONESTAR RACING ALUMINUM ROOF
- 22 LONESTAR RACING FRONT & REAR BUMPERS
- 23 LONESTAR RACING ROCK SLIDERS
- 23 LONESTAR RACING FRONT & REAR INTRUSION BARS
- 23 LONESTAR RACING SPARE TIRE HOLDER
- 23 LONESTAR RACING NUMBER PLATE
- 26 BEARD SUSPENSION SEATS
- 26 4-POINT HARNESS FOR DRIVER & PASSENGER
- 28 LinQ 4.2 GAL (16 L) COOLER
- 35 39" (99 CM) DOUBLE STACKED LED LIGHT BAR (270 WATTS)
- 37 LONESTAR RACING MOUNTS FOR 39" (99 CM) DOUBLE STACKED LED LIGHT BAR
- 38 WET SOUNDS STEALTH 6 ULTRA HD CAN-AM EDITION SOUND BAR
- 42 ADJUSTABLE LIGHTED WHIP FLAG



WE'RE BUILT FOR ACTION

CARVE A NEW LINE WITH TRAIL-TUNED MAVERICK SPORT—WITH ACCESSORIES READY, WILLING, AND ABLE TO SHARPEN YOUR RIDE TO PERFECTION



MAVERICK SPORT

- 9 SPORT ROOF
- 13 SIDE MIRRORS
- 17 FRONT & REAR TRAIL BUMPERS
- 19 FRONT CORNER PROTECTORS
- 19 ROCK SLIDERS
- 20 SPARE TIRE CARRIER
- 21 FRONT INTRUSION BAR
- 27 FIXED TAILGATE
- 34 10" (25 CM) BAJA DESIGNS ONX6 LED LIGHT BAR
- 34 BAJA DESIGNS SQUADRON SPORT LED LIGHTS
- 38 COMPLETE WET SOUNDS AUDIO SYSTEM



WE'RE BUILT FOR PLAY



STANDING OUT & GETTING THE MOST FROM THE MAVERICK TRAIL IS A STEP CLOSER WITH DRAGONFIRE'S TOP-TO-BOTTOM ARRAY OF PROTECTION BARS, ENGINEERED TO PERFORM, FIT, AND LOOK LIKE NOTHING ELSE.



MAVERICK TRAIL

- 9 DRAGONFIRE ALUMINUM ROOF
- 13 TINTED HALF WINDSHIELD
- 13 PANORAMIC CENTER MIRROR
- 24 DRAGONFIRE FRONT & REAR BUMPERS
- 25 DRAGONFIRE FRONT EXO-FRAME
- 25 DRAGONFIRE SPARE TIRE HOLDER
- 25 DRAGONFIRE FRONT INTRUSION BAR
- 25 DRAGONFIRE ROCK SLIDERS
- 26 BEARD SUSPENSION SEATS
- 32 LinQ RACK EXTENSION
- 35 10" (25 CM) DOUBLE STACKED LED LIGHT BAR (60 WATTS)
- 46 YOSHIMURA SLIP-ON EXHAUST
- 46 S&B PARTICLE SEPARATOR



WE'RE BUILT FOR 40 BELOW

ONCE ENCLOSED AND FITTED WITH A HEATER SYSTEM, THE MAVERICK TRAIL BECOMES A WINTER WARRIOR. ADD THE CAN-AM PROMOUNT PLOW AND SNOW IS NO LONGER A CHORE.



MAVERICK TRAIL

- 10 SOFT CAB ENCLOSURE
- 14 HALF DOORS
- 40 DEFROST, HEAT & VENTILATION SYSTEM
- 41 HEATED GRAB BAR COVER
- 41 HEATED STEERING WHEEL
- 41 HEATED SEAT COVER
- 44 CAN-AM TERRA 45SR WINCH BY SUPERWINCH
- 49 APACHE 360 LT TRACK SYSTEM
- 51 CAN-AM PROMOUNT STEEL BLADES
- 52 CAN-AM PROMOUNT PUSH FRAME EXTENSION
- 52 CAN-AM PROMOUNT BLADE EXTENSIONS
- 52 CAN-AM PROMOUNT EDGE MARKERS
- 52 CAN-AM PROMOUNT DRIFT CUTTERS

THE BEST FROM OUR PARTNERS



RACE-ENGINEERED TO LONESTAR RACING'S TRADEMARK STANDARDS FOR TOUGHNESS, THESE **STYLISHLY CRAFTED** ACCESSORIES WILL ALSO ENHANCE VEHICLES WITH VISUAL IMPACT.



TRAIL-TOUGH STRENGTH DOESN'T HAVE TO SACRIFICE SHARP LINES. DRAGONFIRE ACCESSORIES ARE DESIGNED TO MATCH THE VEHICLE'S BODY AND GREATLY ENHANCE ITS OVERALL LOOK.

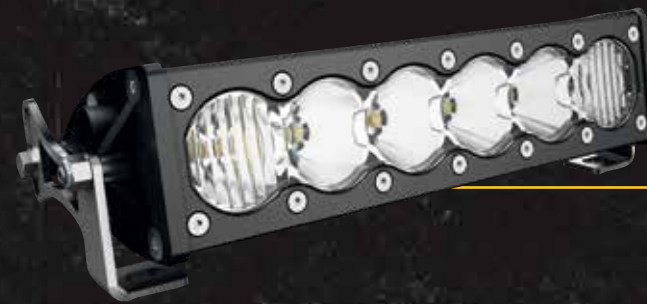

25 YEARS BUILDING LIGHTS MEAN REAL VISION, ANYWHERE, WITH A **LIFETIME WARRANTY**. BAJA DESIGNS LEDS ARE MADE BY THE SCIENTISTS OF LIGHTING TO SHINE AND SURVIVE FAR BEYOND THE BEATEN PATH.



DESIGNED FOR **COMFORT AND STABILITY**, THESE RACE-INSPIRED, 4-POINT-HARNESS-READY SEATS SECURE OCCUPANTS TO LET THEM FOCUS ON WHAT'S IMPORTANT —THEIR DRIVE AND BALANCE OVER CHALLENGING TERRAIN.



SCS WRAP KITS—PERFECTLY-SIZED & **EXCLUSIVE WRAP DESIGNS** THAT WILL COMPLEMENT YOUR MAVERICK TRAIL AND REFRESH ITS LOOK. YOU'RE UNIQUE. YOUR RIDE SHOULD BE TOO.

Available at participating Can-Am dealers and scscanamgraphics.com



SCS wraps are of the highest quality, made with 0.004" engineering-grade vinyl overlaid with a 0.008" UV-protective laminate. That means vibrant colors, easy installation and a wrap that will hold up to the rigors of the off-road. SCS can even customize the color combinations, adding names, numbers and logos according to your exact specifications.



GIVE YOUR
BEAST MORE
BACKBONE



NEW LONESTAR RACING ALUMINUM ROOF

- Race-true low profile look with integrated front visor for eye-popping performance and protection.
- 0.083" (2.1 mm) thick aluminum roof for durable and lightweight protection from the elements.
- Compatible with Lonestar Racing Mounts for 39" (99 cm) Double Stacked LED Light Bar (715004877).
- Not compatible with Full Windshields, Rigid Rear Window, Can-Am Intrusion Bars and Overhead Switch Panel.

Maverick Trail, Maverick Sport

■ 715005137 - Black

■ 715003831 - Can-Am Red



DRAGONFIRE ALUMINUM ROOF

- Durable and lightweight formed aluminum roof with durable powder coat finish.
- Sleek lines designed to match your vehicle's body and greatly enhance overall look.
- Compatible with all windshields

Maverick Trail, Maverick Sport

715004458



BIMINI ROOF WITH SUN VISOR

- Heavy-duty canvas made of UV-resistant solution-dyed polyester.
- Soft top comes with a hard visor that allows for storage of rolled-up soft top and mounting auxiliary lights.

Maverick Trail, Maverick Sport

715003661



SPORT ROOF

- Robust injection-molded polypropylene construction.
- Excellent protection from the elements.
- Allows to install lights at roof top location.
- Windshield compatible.

Maverick Trail, Maverick Sport

715003659



WRAP YOURSELF IN COMFORT

EASILY REMOVE UPPER
SOFT DOOR PANELS
ON THE FLY WHEN
THE WEATHER BRIGHTENS UP!



SOFT CAB ENCLOSURE

• Protection for rider and passenger from the elements.

Included:

- Sport Roof (715003659)
- Full Windshield - Hardcoated (715003656)
- Upper Soft Door Panels (715003620)
- Soft Rear Panel (715003622)
- Door Seal Kit (715004773)
- Requires Half Doors (715004418) on 800 Base and 800 DPS model

Maverick Trail

715003618

CLEARLY SUPERIOR PROTECTION



FULL WINDSHIELD - HARDCOATED

- High-impact-resistant Quantum[®] hardcoated polycarbonate full windshield.
- Formed polycarbonate construction for enhanced rigidity.
- Provides excellent optical clarity and better abrasion resistance.
- Seals firmly against the cage and protects rider and passenger from the elements.
- Must be used with a rear wind protection.
- Quick and easy tool-less installation or removal.

Maverick Trail, Maverick Sport

715003656



FULL WINDSHIELD

- High-impact-resistant durable polycarbonate full windshield.
- Formed polycarbonate construction for enhanced rigidity.
- Seals firmly against the cage and protects rider and passenger from the elements.
- Formulated to be non-yellowing, non-crazing, non-cracking with excellent UV resistance and optical clarity.
- Must be used with a rear wind protection.
- Quick and easy tool-less installation or removal.

Maverick Trail, Maverick Sport

715003655



DESIGN YOUR OWN CAB. Pick the accessories of your choice and **build** or **complete** your own cab.

100% MODULAR COMPONENTS DESIGNED TO WORK TOGETHER: **ROOFS** P.8 **WINDSHIELDS** P.11 **DOORS** P.14 **REAR WINDOWS** P.15



REVERSE ANGLE LIP DEFLECTS AIR FLOW

GLASS WINDSHIELD

- Curved and laminated glass full windshield in metal frame.
- Provides excellent optical clarity.
- Seals firmly against the cage and protects rider and passenger from the elements.
- Must be used with Windshield Wiper and Washer Kit (715003654) to maintain clear visibility during severe riding conditions, such as mud riding.
- Must be used with a rear wind protection.
- Not EC compliant.

Maverick Trail, Maverick Sport
715003653

GLASS WINDSHIELD WITH WIPER

- Curved and laminated glass full windshield in metal frame.
- Provides excellent optical clarity.
- Seals firmly against the cage and protects rider and passenger from the elements.
- Single-speed wiper with washer fluid dispenser.
- Requires the Overhead Switch Panel (715003669) for installation.
- Must be used with a rear wind protection.
- Not EC compliant.

Maverick Trail, Maverick Sport
715003652

WINDSHIELD WIPER & WASHER KIT

- An ideal way to keep your windshield clear in rain, or while riding through mud and water.
- Includes single-speed wiper, washer fluid dispenser and windshield frame mount.
- Must be used with the Glass Windshield (715003653).
- Requires the Overhead Switch Panel (715003669) for installation.
- Not EC compliant.

Maverick Trail, Maverick Sport
715003654

HALF WINDSHIELD

- Formed polycarbonate construction for enhanced rigidity.
- Formulated to be non-yellowing, non-crazing, non-cracking with excellent UV resistance and optical clarity.
- Protects driver and passenger from the elements.
- Features reverse angle lip to deflect air flow.
- Quick and easy tool-less installation or removal.

Maverick Trail, Maverick Sport

CLEAR WINDSHIELD

715003657



NEW TINTED WINDSHIELD

715005280



SIDE MIRRORS

- Rugged black nylon 6/6 construction with coated cast-aluminum mount.
- Dual-adjustment (horizontal and vertical) will suit any rider.
- Convex optics deliver optimal field of view (FOV).
- Spring-loaded pivots let mirrors fold back completely.
- Sold in pairs.

Maverick Trail, Maverick Sport
715003639



PANORAMIC CENTER MIRROR

- Wide-angle convex mirror.
- Offers enhanced visibility.
- Can be used with or without roof or windshield.

Maverick Trail, Maverick Sport
715003638



Some products shown may not be available or homologated in your country. Contact your BRP dealer for local details.



COMFORT,
PROTECTION &
GREAT LOOKS
BUILT TO OUTLAST
ANY TRAIL

HALF DOORS

- Half doors made of molded HDPE to match vehicle's styling.
- Steel frame for high level of rigidity.
- A must-have for additional cabin comfort.
- Door Trim is required to complete your door kit (sold separately).
- Standard on 1000 Base and 1000 DPS models.
- Sold in pairs.

Maverick Trail
715004418



DOOR TRIM

- Matching colored panel for the Half Doors.
- Required to complete the Half Doors (sold separately).
- Sold in pairs.

Maverick Trail

- 715004802- White
- 715005083- Sunburst Yellow

DOOR SEAL KIT

- (Not illustrated)
- Improves door sealing from the elements and provides additional cabin comfort.
- Included in the Soft Cab Enclosure Kit.

Maverick Trail
715004773

UPPER SOFT DOOR PANELS

- Upper canvas portion of the doors with sturdy steel frame.
- Seals firmly against the cage and protects rider and passenger from the elements.
- Converts half door into full door for a complete cab enclosure.
- Zippered window made of laminated polished vinyl material for added ventilation.
- Easy to remove on hot and sunny days.
- Must be used with the Sport Roof for maximum sealing.
- Requires Half Doors (715004418) on 800 Base and 800 DPS models.

Maverick Trail
715003620



DOOR KNEE PADS WITH STORAGE

- Padded door cushion with integrated pocket for storage.
- Protects driver and passenger legs from contacting the doors while riding.
- Increases cabin comfort.
- Requires Half Doors (715004418) on 800 Base and 800 DPS models.
- Offers storage space for small items.
- Sold in pairs.

Maverick Trail
715003635



STAY CLEANER
AND WARMER
RIDING THROUGH
THE WORST

NEW REAR POLYCARBONATE WINDOW

- High-impact-resistant polycarbonate window.
- Blocks windshield backdraft or dust and rain from entering for added cabin comfort.
- Sport Roof is required for installation.
- Not compatible with Bimini Roof with Sun Visor, Dragonfire Aluminum Roof and Lonestar Racing Aluminum Roof.

Maverick Trail, Maverick Sport
715004227

SOFT REAR PANEL

- Plastic reinforced and weather-resistant rear panel offers good protection from the elements.
- Made of heavy-duty UV-resistant solution-dyed polyester canvas for excellent resistance to tear and abrasion.
- Clear window made of laminated polished vinyl material.
- Resists cold cracking.
- Installs quick and easily on roll cage.

Maverick Trail, Maverick Sport
715003622

REAR WIND SCREEN

- Full rear mesh screen reduces windshield backdraft for added cabin comfort.
- Installs quick and easily on roll cage.
- Large Can-Am Branding.

Maverick Trail, Maverick Sport
715003664



HMWPE SKID PLATES

Our Plastic Plates glide smoothly and silently over obstacles, offering great protection in rough terrain. Made of abrasion-resistant thermoformed High Molecular Weight Polyethylene (HMWPE). Lighter than aluminum. Superior stress crack resistance. High impact strength.

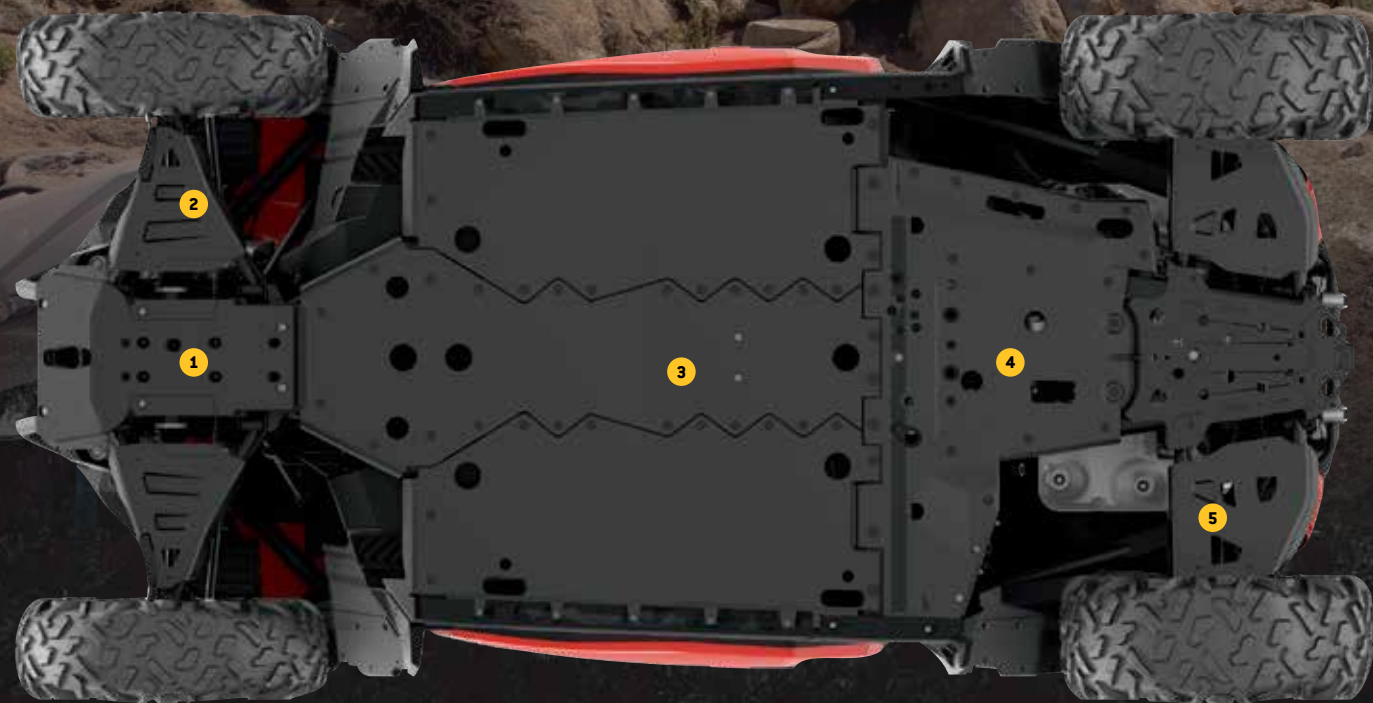

OFFER YOUR MAVERICK SPORT AND MAVERICK TRAIL THE FULL PROTECTION KIT OR GET THEM INDIVIDUALLY

FIND YOUR MODEL

	MAVERICK SPORT	MAVERICK TRAIL
HMWPE SKID PLATE PROTECTION KIT	715004269 NEW	715003715
HMWPE SKID PLATES • 3/8" (10 mm) thick high molecular weight polyethylene (HMWPE).		
1 HMWPE FRONT SKID PLATE	715004260	715004260
2 HMWPE FRONT A-ARM PROTECTORS	715004270 NEW	715003698
3 HMWPE UNDERBELLY PLATES • Keeps the roll over clearance.	715003697	715003697
4 HMWPE REAR SKID PLATE	715004261	715004261
5 HMWPE REAR A-ARM PROTECTORS	715004271 NEW	715003699

Some products shown may not be available or homologated in your country. Contact your BRP dealer for local details.

GET TOUGH
WITH TRAIL OBSTACLES
BY ADDING ARMOR-
GRADE PROTECTION.
IT'S PROTECTION TO
BE RECKONED WITH!



FRONT TRAIL BUMPER

- Front bumper made of heavy-duty 1.5" (3.8 cm) diameter steel tubing.
- Completes the stock bumper for more front coverage and essential vehicle protection for trail riders.
- Inside and outside anti-corrosion coating with durable powder coat finish.
- Includes integrated mount points for light installation.

Maverick Trail, Maverick Sport

- 715003680 - Black
- 715003681 - Sunburst Yellow **NEW**



REAR TRAIL BUMPER

- Rear bumper made of heavy-duty 1.5" (3.8 cm) diameter steel tubing.
- Protects vehicle bodywork and exhaust system.
- Inside and outside anti-corrosion coating with durable powder coat finish.

Maverick Trail, Maverick Sport

- 715003683 - Black
- 715003684 - Sunburst Yellow **NEW**





ROCK SLIDERS

REAR TRAIL BUMPER

360 DEGREES OF HIGH STRENGTH & HIGH STYLE PROTECTION



FRONT CORNER PROTECTORS

FRONT TRAIL BUMPER

FRONT INTRUSION BAR



CATCH THE VIDEO
CAN-AMOFFROAD.COM

FRONT CORNER PROTECTORS

- Heavy-duty 1.5" (3.8 cm) diameter steel-tube construction.
- Inside and outside anti-corrosion coating with durable powder coat finish.
- Provides additional protection for vehicle's front corners.
- Requires Front Trail Bumper for installation (not compatible with the Front Rancher Bumper).
- Sold in pairs.

Maverick Trail, Maverick Sport

- 715004912 - Black
- 715005230 - Sunburst Yellow **NEW**



ROCK SLIDERS

- Made of heavy-duty 1.5" (3.8 cm) diameter steel tubing.
- Inside and outside anti-corrosion coating with durable powder coat finish.
- Protect vehicle's rocker panels and undercarriage against large obstacles.
- Sold in pairs.

Maverick Trail, Maverick Sport

- 715003689 - Black
- 715005228 - Sunburst Yellow **NEW**



RANCHER FRONT BUMPER

- Heavy-duty protection made of 1.5" (3.8 cm) diameter steel tubing, perfect for farm, ranch and forestry applications.
- Inside and outside anti-corrosion coating with durable powder coat finish.
- Offers full front coverage and superior headlight protection.
- Removable radiator protector to allow light installation.
- Rugged look.

Maverick Trail, Maverick Sport

715004303



RANCHER REAR BUMPER

- Heavy-duty protection made of 1.5" (3.8 cm) diameter steel tubing, perfect for farm, ranch and forestry applications.
- Inside and outside anti-corrosion coating with durable powder coat finish.
- Offers full rear coverage with integrated tail light protectors.

Maverick Trail, Maverick Sport

715004304





HIGH STRENGTH
& STYLE TO
PREVENT
INTRUSIONS

TAIL LIGHT PROTECTORS

- Anti-corrosion coating with durable powder coat finish.
- Rugged style, aggressive look.
- Sold in pairs.
- Not EC compliant.

Maverick Trail, Maverick Sport
715003692



SPARE TIRE CARRIER

- Holds spare tire in place.
- Designed for fast tire removal.
- Can hold tires up to 30" in diameter (tire is not included).
- Rear bumper mounted, does not encumber the cargo area.
- Made of heavy-duty 1.5" (3.8 cm) diameter steel tubing.
- Inside and outside anti-corrosion coating with durable powder coat finish.
- The Wheel Jack (715001719) can be attached by using the Spare Tire Ratchet Tie-Downs (280000606).
- Requires Rear Trail Bumper (715003683) or Rear Rancher Bumper (715004304).

Maverick Trail, Maverick Sport
715004471



2" (51 MM) FENDER FLARES

- Fender flares made from injection-molded polypropylene.
- Keep mud and debris out of vehicle.
- Designed for quick and easy installation.
- Include front and rear extensions and mounting hardware.
- Increase vehicle's overall width by 3.5" (8.9 cm).

Maverick Trail
715003625



NEW 3" (76 MM) FENDER FLARES

- Fender flares made from injection-molded polypropylene.
- Keep mud and debris out of vehicle.
- Designed for quick and easy installation.
- Include front and rear extensions and mounting hardware.
- Increase vehicle's overall width by 6" (15.3 cm) when installed on Maverick Trail models.
- Standard on Maverick Sport models.

Maverick Trail, Maverick Sport
715004959



NEW FRONT INTRUSION BAR

- Steel intrusion bar matches perfectly with vehicle's styling.
- Inside and outside anti-corrosion coating with durable powder coat finish.
- Provides additional protection by preventing large objects from entering the driver/passenger area.
- Tube design reduces obstructed lines of sight and blind spots for better visibility.
- Not compatible with windshields and Soft Door Panels.

Maverick Trail, Maverick Sport
715003872



RADIATOR PROTECTOR

- Perforated steel shield mounted over the radiator face, providing protection from stones and branches.
- Not recommended for winter use.

Maverick Trail, Maverick Sport
715003700

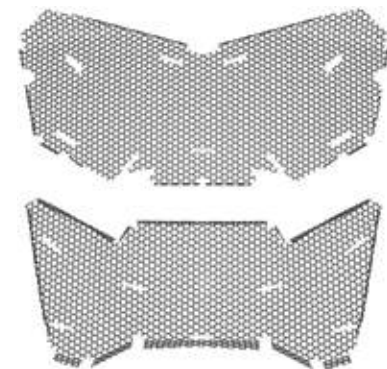

Some products shown may not be available or homologated in your country. Contact your BRP dealer for local details.



PEAK PERFORMANCE
NEVER LOOKED SO HOT



NEW LONESTAR RACING FRONT BUMPER

- Race-engineered to Lonestar Racing's trademark standards for toughness, these stylishly crafted accessories will also enhance your vehicle with visual impact.
- Made of 1.5" (3.8 cm) diameter steel tubing with durable powder coat finish.
- Billet end-cap with Lonestar Racing logo.
- Compatible with synthetic rope Winches and Hawse Fairlead.

Maverick Trail, Maverick Sport

- 715005131 - Black
- 715004871 - Can-Am Red



NEW LONESTAR RACING REAR BUMPER

- Race-engineered to Lonestar Racing's trademark standards for toughness, these stylishly crafted accessories will also enhance your vehicle with visual impact.
- Made of 1.5" (3.8 cm) diameter steel tubing with durable powder coat finish.
- Billet end-cap with Lonestar Racing logo.
- Provides additional vehicle-rear bodywork and exhaust system protection in extreme driving conditions.

Maverick Trail, Maverick Sport

- 715005133 - Black
- 715004873 - Can-Am Red



NEW LONESTAR RACING FRONT INTRUSION BAR

- Race-engineered to Lonestar Racing's trademark standards for toughness, these stylishly crafted accessories will also enhance your vehicle with visual impact.
- Made of 1.5" (3.8 cm) diameter steel tubing with durable powder coat finish.
- Provides additional protection for driver and passenger.
- Compatible with Lonestar Racing Aluminum Roof.
- Not compatible with windshields, Bimini Roof with Sun Visor and Sport Roof.

Maverick Trail, Maverick Sport

- 715005132 - Black
- 715004872 - Can-Am Red



NEW LONESTAR RACING REAR INTRUSION BAR

- Race-engineered to Lonestar Racing's trademark standards for toughness, these stylishly crafted accessories will also enhance your vehicle with visual impact.
- Made of 1.5" (3.8 cm) diameter steel tubing with durable powder coat finish.
- Provides additional protection for driver and passenger.
- Not compatible with the Sport Roof, rear panels and window, All-Terrain Trunk Cover and S&B Pre-Filter.

Maverick Trail, Maverick Sport

- 715005134 - Black
- 715004874 - Can-Am Red



NEW LONESTAR RACING ROCK SLIDERS

- Race-engineered to Lonestar Racing's trademark standards for toughness, these stylishly crafted accessories will also enhance your vehicle with visual impact.
- Made of 1.5" (3.8 cm) diameter steel tubing with durable powder coat finish filled with 1/8" (3 mm) aluminum plate.
- Billet end-cap with Lonestar Racing logo.
- Protect vehicle sides from large obstacles.
- Sold in pairs.

Maverick Trail, Maverick Sport

- 715005135 - Black
- 715004875 - Can-Am Red



NEW LONESTAR RACING SPARE TIRE HOLDER

- Race-conceived for riders who believe a Plan B means thinking like a pro.
- Hold wheel securely no matter how rough the trail.
- Made of 1.5" (3.8 cm) diameter steel tubing with durable powder coat finish.
- Easy, bolt-on installation on roll cage.
- Can accommodate tires up to 27".
- Wheel not included.
- Not compatible with All-Terrain Trunk Cover, Fixed Tailgate, LinQ Cargo Rack and LinQ Rack Extension.

Maverick Trail, Maverick Sport

- 715005136 - Black
- 715004876 - Can-Am Red



NEW LONESTAR RACING NUMBER PLATE

- Race-bred in the Lonestar tradition of competition-level riding, this number plate will brand your vehicle a winner.
- Includes a pair of sturdy aluminum number plates.
- Create your personalized number decal through SCS Unlimited.
- Not compatible with the All-Terrain Trunk Cover.

Maverick Trail, Maverick Sport

715004878



Some products shown may not be available or homologated in your country. Contact your BRP dealer for local details.



STORM THE TRAILS AND BEYOND WITH DRAGONFIRE'S ENGINEERED PROTECTION FOR YOUR MAVERICK TRAIL & MAVERICK SPORT



DRAGONFIRE FRONT BUMPER

- 1.5" (3.8 cm) diameter steel tubing with durable powder coat finish and reinforced with a 2.3 mm thick steel plate.
- Combines perfectly with the DragonFire Front Exo-Frame.
- Delivers additional protection for your vehicle.
- Not compatible with the Front Hitch Receiver.
- Sleek lines designed to match your vehicle's body and greatly enhance overall look.
- Includes brackets for auxiliary light mounting.

Maverick Trail, Maverick Sport

- 715004456 - Can-Am Red
- 715005128 - Black **NEW**



DRAGONFIRE REAR BUMPER

- 1.5" (3.8 cm) diameter steel tubing with durable powder coat finish and reinforced with a 2.3 mm thick steel plate.
- Delivers additional protection for your vehicle.
- Sleek lines designed to match your vehicle's body and greatly enhance overall look.
- Billet End Caps with DragonFire Logo.

Maverick Trail, Maverick Sport

- 715004457 - Can-Am Red
- 715005129 - Black **NEW**



DRAGONFIRE FRONT INTRUSION BAR

- 1.25" (3.2 cm) diameter steel tubing with durable powder coat finish.
- Provides additional protection for driver and passenger.
- Unique conception with a centered upper portion to minimize effects on visibility.
- Sleek lines designed to match your vehicle's body and greatly enhance overall look.
- Compatible with all polycarbonate windshields and all roofs.

Maverick Trail, Maverick Sport

- 715004455 - Can-Am Red
- 715005126 - Black **NEW**



DRAGONFIRE FRONT EXO-FRAME

- 1.5" (3.8 cm) diameter steel tubing with durable powder coat finish.
- Provides full front-corner and side-body protection.
- Sleek lines designed to match your vehicle's body and greatly enhance overall look.
- DragonFire Front Bumper is required for installation.
- Sold in pairs.

Maverick Trail, Maverick Sport

- 715004801 - Can-Am Red
- 715005127 - Black **NEW**



DRAGONFIRE SPARE TIRE HOLDER

- 1.5" (3.8 cm) diameter steel tubing with durable powder coat finish.
- Sleek lines designed to match your vehicle's body and greatly enhance overall look.
- Easy-to-install roll cage mounted spare-tire holder.
- Accommodates tires up to 28" in diameter (wheel not included).
- Uses standard bolt pattern for wheel installation.
- Not compatible with All-Terrain Trunk, Gear Rail and LinQ accessories mounted in the cargo bed.

Maverick Trail, Maverick Sport

- 715004443 - Can-Am Red
- 715005125 - Black **NEW**



DRAGONFIRE ROCK SLIDERS

- 1.25" (3.2 cm) diameter steel tubing with durable powder coat finish.
- Sleek lines designed to match your vehicle's body and greatly enhance overall look.
- Protects vehicle's undercarriage with minimal effect on ground clearance.
- 2.3 mm steel plate wraps the lower side of the vehicle for additional lateral protection.
- Sold in pairs.

Maverick Trail, Maverick Sport

- 715003690 - Can-Am Red
- 715005130 - Black **NEW**



Some products shown may not be available or homologated in your country. Contact your BRP dealer for local details.

EXCLUSIVE CONTROLLED DECELERATOR ABSORBS ENERGY IN CASE OF AN ACCIDENT



4-POINT HARNESS

- Exclusive controlled decelerator technology (patent pending) absorbs additional energy in case of an accident.
- Designed to offer maximum riding comfort.
- Easy one-click latch and release.
- Not EC compliant.
- ROHVA compliant.

Maverick Trail, Maverick Sport
 715004234 • Driver
 715004235 • Passenger



SEAT BELT SHOULDER PADS

- Provide additional riding comfort by preventing seat belt from rubbing on neck and shoulder.
- Fit with standard 3-point seat belts.
- Easy Velcro installation.
- Can-Am branded.
- Sold in pairs for driver and passenger.

Maverick Trail, Maverick Sport
 715002894



BEARD SUSPENSION SEATS

- True suspension seating for driver and passenger seats.
- Designed specifically for side-by-side vehicle applications.
- Offer great posture for both driver and passenger during intense riding conditions.
- Feature a high and unmatched level of containment support, which gives superior comfort and stability.
- Made of rigid welded-steel frame, covered with sculpted foam and wrapped with a custom cover of premium marine-grade vinyl, which is durable in all driving conditions and resistant to mildew and fading.
- Enhance the racing look of the vehicle.
- No additional seat mounts required.
- Sold in pairs.

Maverick Trail, Maverick Sport
 ■ 715004459 • Black
 ■ 715004460 • Can-Am Red



ENGINEERED FOR PERFORMANCE.
 BUILT FOR PERFORMANCE DRIVERS

HAS YOUR ADVENTURES COVERED



ALL-TERRAIN TRUNK COVER

- Transforms your rear cargo area into a fully enclosed and weather-resistant car-like trunk box.
- Gas spring assisted opening.
- Integrated mounting location inside the trunk cover for Dome Light (715002455) sold separately.
- Rotomolded construction provides exceptional rigidity.
- LinQ accessories can be installed on or inside the trunk cover.
- LinQ Cargo Base Kit (860201806) required for installation on the trunk cover.

Maverick Trail, Maverick Sport
 715003701



FIXED TAILGATE

- Rigid rotomolded construction.
- Encloses perfectly the rear cargo opening and helps to keep cargo securely in place.
- Matches vehicle styling.

Maverick Trail, Maverick Sport
 715004357



Some products shown may not be available or homologated in your country. Contact your BRP dealer for local details.

EQUIPPING YOUR MAVERICK WITH AMPLE CARGO CAPACITY **ONLY MAKES PACKING EASIER, AND THE RIDE, BETTER**



CATCH THE VIDEO
CAN-AMOFFROAD.COM



LinQ 4.2 GAL (16 L) COOLER

- All the benefits of LinQ - simple, fast and secure.
- Rotomolded construction for exceptional rigidity and durability.
- Premium-quality foam insulation for optimal ice retention.
- Utilizes LinQ mounting system (Patent US 8777531 and US 8875830).
- Easy one-second on/off tool-less system.
- LinQ Cargo Base Kit (860201806) required for installation.
- LinQ Base Installation Kit (715004461) required for rear cargo installation or Passenger Seat Base LinQ Kit (715003951) required for passenger seat installation.

Maverick Trail, Maverick Sport
295100698



SR 5.5 GAL (21L) LinQ BAG

- All the benefits of LinQ - simple, fast and secure.
- Semi-rigid expandable bag.
- 5.5 Gal (21L) capacity.
- Utilizes LinQ mounting system (Patent US 8777531 and US 8875830).
- Easy one-second on/off tool-less system.
- LinQ Cargo Base Kit included (860201806).
- LinQ Base Installation Kit (715004461) required for rear cargo installation or Passenger Seat Base LinQ Kit (715003951) required for passenger seat installation.

Maverick Trail, Maverick Sport
860201740



LinQ PREMIUM STORAGE BAG BY OGIO

- Tool-less installation and removal thanks to the LinQ system.
- 17.2 Gal (65 L) capacity semi-rigid cargo bag ideal for carrying anything you need on your vehicle.
- Buckle and elastic closure with a rubber seal that protects dust from entering the bag.
- 3-section lid for partial or full access to your bag.
- Inside separators for optimal bag organization.
- LinQ Cargo Rack (715003702) required for installation.

Maverick Trail, Maverick Sport

- 715002923 - Black
- 715003248 - Mossy Oak Break-Up Country Camo



INSIDE SEPARATORS FOR OPTIMAL BAG ORGANIZATION.



LinQ 12 GAL (45L) CARGO BOX

- LinQ mounted for easy-on, easy-off installation.
- Holds cargo safely and securely while riding.
- LinQ Cargo Rack (715003702) is required.

Maverick Trail, Maverick Sport
715003879



LinQ 23 GAL (86L) TRUNK BOX

- LinQ mounted for easy-on, easy-off installation.
- Lockable and weather-resistant.
- Holds cargo safely and securely while riding.

Maverick Trail, Maverick Sport
715004923

- LinQ Cargo Rack (715003702) required for installation.



PASSENGER SEAT BASE LinQ KIT

- LinQ base kit that installs on the passenger seat frame underneath the bottom seat cushion.
- Allows installation of compatible LinQ accessories inside the cabin.
- Passenger seat cushion can be reinstalled over the LinQ base kit when not in use.

Maverick Trail, Maverick Sport
715003951



LinQ CARGO BASE KIT

- Unique mounting fastener usable on any LinQ System accessory.
- Included: 2 Cargo LinQ bases and hardware.

Maverick Trail, Maverick Sport
860201806



LinQ BASE INSTALLATION KIT

- (Not illustrated)
- Required to install LinQ Cargo Base Kit in cargo box.

Maverick Trail, Maverick Sport
715004461



LinQ REPLACEMENT PART

- (Not illustrated)
- Unique mounting fastener usable on any LinQ System accessory.
- Tool-less installation and removal.
- Sold in pairs.

Maverick Trail, Maverick Sport
715001707

Some products shown may not be available or homologated in your country. Contact your BRP dealer for local details.



LinQ 32 GAL (124L) TRUNK BOX

- Equipped with the LinQ System, the rear trunk box plugs in and out in seconds.
- 32 Gal (124L) load capacity with unobstructed space to maximize storage room and access to the trunk's interior.
- Made of injection-molded polyethylene, double walled in critical areas.
- The fully sealed lid protects your belongings from dust, moisture and the elements.
- Trunk Box Panels available in many colors to match your vehicle (sold separately).
- LinQ Cargo Rack (715003702) required for installation.

Maverick Trail, Maverick Sport
715001747 • Black (Rear tail light included)

European version (EC compliant)
715001748 (No rear tail light)



LinQ 32 GAL (124L) TRUNK BOX PANELS

- Color panels to match the LinQ 32 Gal (124L) to your vehicle.

Maverick Trail, Maverick Sport

- | | |
|-------------------------|---------------------------|
| ■ 715001391 • Black | ■ 715002480 • Light Grey |
| ■ 715001392 • Yellow | ■ 715002984 • Octane Blue |
| ■ 715001395 • Viper Red | ■ 715002985 • Manta Green |
| ■ 715002481 • White | ■ 715002986 • Can-Am Red |

European Version (EC compliant)

- No rear tail light
- 715001397 • Black
- 715001398 • Yellow
- 715002482 • Light Grey
- 715002483 • White



LinQ 11.5 GAL (43L) AUDIO CARGO BOX

- An affordable and quick solution for adding music and storage to your next ride.
- The rear installation does not use up any cab space and allows easy listening at an average speed.
- Mounts on/off easily to hold/carry cargo safely and securely.
- The Bluetooth enabled receiver and 6.5" (16.5 cm) speakers are smartly concealed and integrated in the cover.
- Automatic shut-off function protects your battery by turning the system off after 10 minutes of inactivity.
- Backlit control panel perfect for night riding.
- Water-resistant speakers.
- LinQ Cargo Rack (715003702) required for installation.

Maverick Trail, Maverick Sport
715003018



**IT'S A CARGO BOX.
IT'S AN AUDIO RECEIVER &
SPEAKER SYSTEM. IT'S LinQ VERSATILITY
& CAN-AM INNOVATION.**



CATCH THE VIDEO
CAN-AMOFFROAD.COM

CARGO BAG

- Rugged all-purpose cargo bag with rain cover for additional protection against the elements.

Maverick Trail, Maverick Sport
280000539



**RAIN COVER FOR
ADDITIONAL PROTECTION**



STORAGE 2.6 GAL (10L) BAG

- Roll-top dry bag for fully protecting your cargo from the elements.

Maverick Trail, Maverick Sport
269502121



LinQ TOOL HOLDER

- Ultra-versatile tool holder.
- Convenient swivel-latch allows tools to be stored in any orientation.
- Sold in pairs.
- LinQ Base Installation Kit (715004461) and LinQ Cargo Base Kit (860201806) required for cargo bed installation.

Maverick Trail, Maverick Sport
715003059



SOFT COOLER

- Soft cooler made of durable canvas.
- Removable shoulder strap and carry handles.
- Foam insulation and water-resistant interior liner.
- 2.2 Gal (4.5 L) capacity.

Maverick Trail, Maverick Sport
715003728



SOFT STORAGE BAG

- (Not illustrated)
- 3-section bag.
- Transport gear in a weatherproof bag.
- 11.8 Gal (45L) capacity soft cargo bag designed with vehicle's rear in mind to maximize potential storage.

Maverick Trail, Maverick Sport

- 715003759 • Black
- 715001935 • Mossy Oak Break-Up Country Camo



STRONGHOLD AUTO-LATCH MOUNT BY KOLPIN

- Auto-latching design provides quick and secure gun boot attachment to your vehicle.
- Bracket is made from rugged high impact, reinforced nylon and coated steel.
- For use with Stronghold Gun Boot (705011442).
- Requires Gear Rail (715003703).

Maverick Trail, Maverick Sport
715003899



STRONGHOLD GUN BOOT IMPACT[®] BY KOLPIN[®]

- Compact low-profile design with Kolpin Stronghold styling securely holds up to 52" long rifles and shotguns with optics.
- Includes a removable, shock absorbing foam Impact[®] liner.
- Single-handed opening with an attached lid for quick access along with an integrated closure strap.
- For use with the Kolpin Stronghold Auto Latch Mount System.

Maverick Trail, Maverick Sport
705011442



GEAR RAIL

- Sturdy gear rail design with C-clamps attached on the roll cage.
- Offers mounting points for the Stronghold Auto-Latch Mount or for the Universal Saw Press by Kolpin.
- Can hold up to two gun boots.
- Not compatible with the Gun Boot 6.0 Impact by Kolpin (715001419).

Maverick Trail, Maverick Sport
715003703



UNIVERSAL SAW PRESS BY KOLPIN

- Specially crafted for transporting your chainsaw securely and safely aboard your side-by-side vehicle.
- Heavy-duty, black powder-coated metal bracket designed to attach any chainsaw model with up to a 20" (51 cm) bar.
- Rubber pads provide cushion and tight fit.
- Hinged design for quick removal.
- Holds saw in vertical position or 45° angle in either direction.
- Requires Gear Rail (715003703).
- Protective sheath included.

Maverick Trail, Maverick Sport
715001423



FRONT RACK

- Rugged looking front rack mounts on top of vehicle hood and provides additional protection and cargo capacity.
- Heavy-duty 3/4" (1.9 cm) diameter steel-tube construction.
- Inside and outside anti-corrosion coating with durable powder coat finish.
- Flip-up configuration provides easy access to service area.
- 50 lb (22.7 kg) load capacity.
- Can be installed with or without a front bumper.
- Not compatible with DragonFire Front Exo-Frame.

Maverick Trail, Maverick Sport
715004302



LinQ RACK EXTENSION

- Made of strong and durable die cast aluminum.
- Helps to keep cargo securely in place.
- Easy and tool-less installation thanks to the LinQ system.

Maverick Trail, Maverick Sport
715003771



LinQ CARGO RACK

- Made of durable die cast aluminium and strong aluminium tubing frame.
- Allows the installation of LinQ Trunk Boxes on top, and the addition of more LinQ accessories in cargo box.
- Easy and tool-less installation thanks to the LinQ system.

Maverick Trail, Maverick Sport
715003702



39" (99 CM)
DOUBLE
STACKED LED
LIGHT BAR
(270 WATTS)

15" (38 CM)
DOUBLE
STACKED LED
LIGHT BAR
(90 WATTS)

CAN-AM LED
SIGNATURE
LIGHTS

BAJA DESIGNS
XL SPORT
LED LIGHTS

**EXTEND THE
GOOD TIMES
WITH LIGHTS
CUSTOM FIT
FOR YOU**

7,350 LUMENS



10" OnX6 Combo

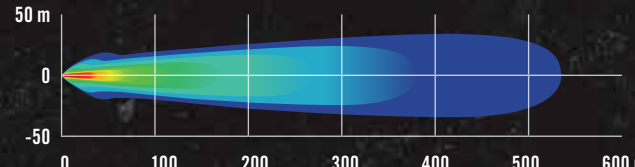

50 m
0
-50
0 100 200 300 400 500 600 m

1,800 LUMENS



XL Sport Spot

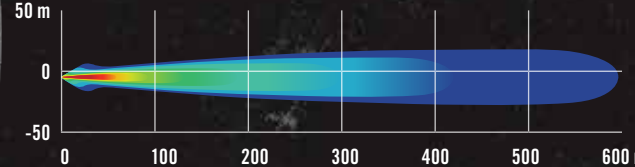

50 m
0
-50
0 100 200 300 400 500 600 m

1,800 LUMENS



Squadron Sport Wide Cornering

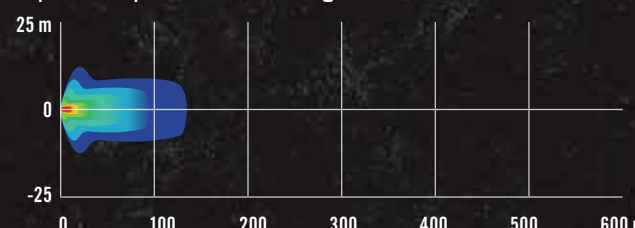

25 m
0
-25
0 100 200 300 400 500 600 m

9,500 LUMENS



XL80 Combo

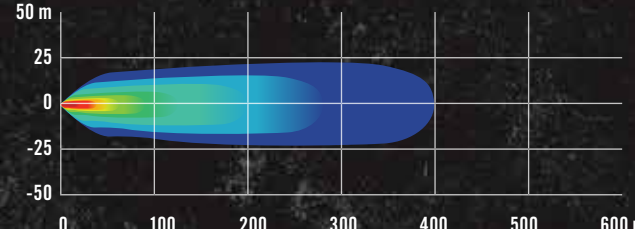

50 m
25
0
-25
-50
0 100 200 300 400 500 600 m



10" (25 CM) BAJA DESIGNS ONX6 LED LIGHT BAR

- 58.5W light bar producing 7,350 lumens.
- Equipped with 6 Cree XM-L2 LEDs.
- Driving/Combo light pattern for smooth blend of light for both near field applications and distance.
- Dual intensity (high/low) settings + strobe mode.
- Can be installed on Can-Am Front Bumpers, Sport Roof and Bimini Roof.
- Requires Baja Designs Light Power Cable.

Maverick Trail, Maverick Sport
710004881



BAJA DESIGNS XL SPORT LED LIGHTS

- 20W per spot producing 1,800 lumens.
- Equipped with 4 Cree XP-G2 LEDs per spot.
- High Speed Spot features a longer and narrower beam focus for illumination farther down.
- Can be installed on Can-Am Front Bumpers, Sport Roof and Bimini Roof.
- Requires Baja Designs Light Power Cable.
- Dimensions: 4.5" x 4.5" (11.4 cm x 11.4 cm).
- Sold in pairs.

Maverick Trail, Maverick Sport
710005287



BAJA DESIGNS SQUADRON SPORT LED LIGHTS

- 20W per spot producing 1,800 lumens.
- Equipped with 4 Cree XP-G2 LEDs per spot.
- Can be installed on Can-Am Front Bumpers, Sport Roof and Bimini Roof.
- Requires Baja Designs Light Power Cable.
- Wide cornering light pattern designed specifically for cornering, dust and/or fog conditions.
- Sold in pairs.
- Dimensions: 3" x 3" (7.6 cm x 7.6 cm).

Maverick Trail, Maverick Sport
710004648



BAJA DESIGNS XL80 LED LIGHTS

- 80W per spot producing 9,500 lumens.
- Equipped with 4 Cree XHP50 LEDs per spot.
- Dual intensity (high/low) settings.
- Driving/Combo light pattern for smooth blend of light for both near field applications and distance.
- Can be installed on Can-Am Front Bumpers, Sport Roof and Bimini Roof.
- Requires Baja Designs Light Power Cable.
- Dimensions: 4.5" x 4.5" (11.4 cm x 11.4 cm).
- Sold in pairs.

Maverick Trail, Maverick Sport
710005041

24,300 LUMENS



39" (99 CM) DOUBLE STACKED LED LIGHT BAR (270 WATTS)

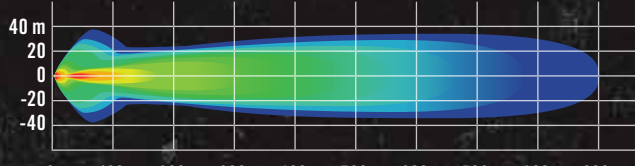

40 m
20
0
-20
-40
0 100 200 300 400 500 600 700 800 900 m

- Equipped with 54 5W Cree LEDs.
 - 24,300 lumens.
 - Not compatible with Full Windshield, Flip Windshield and Intrusion Bar.
 - Requires Light Mounting Kit for 39" (99 cm) LED Light Bar (715003141).
- Maverick Trail, Maverick Sport**
715004007

8,400 LUMENS



15" (38 CM) DOUBLE STACKED LED LIGHT BAR (90 WATTS)

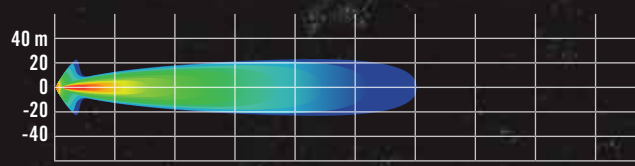

40 m
20
0
-20
-40
0 100 200 300 400 500 600 700 800 900 m

- Equipped with 18 5W Cree LEDs.
 - 8,400 lumens.
 - Complements the Light Rack and most bumpers.
 - Can be installed on Sport Roof and Bimini Roof.
- Maverick Trail, Maverick Sport**
715002934

5,400 LUMENS



10" (25 CM) DOUBLE STACKED LED LIGHT BAR (60 WATTS)

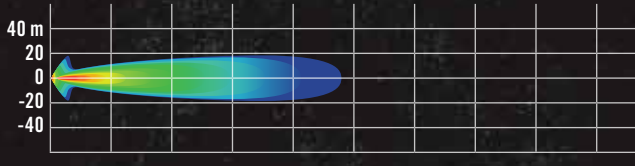

40 m
20
0
-20
-40
0 100 200 300 400 500 600 700 800 900 m

- Equipped with 12 5W Cree LEDs.
 - 5,400 lumens.
 - Packs a big punch for its size.
 - Can be installed on Can-Am Front Bumpers, Sport Roof and Bimini Roof.
 - Requires Light Power Cable for installation.
- Maverick Trail, Maverick Sport**
715002933

1,800 LUMENS



4" (10 CM) ROUND LED LIGHTS (2 X 25 WATTS)

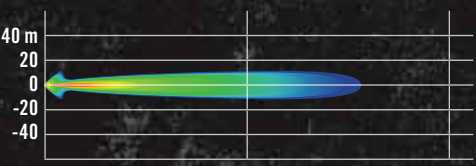

40 m
20
0
-20
-40
0 100 200 m

- 25W LED spotlights.
 - 1,800 lumens.
 - Rugged and waterproof.
 - Includes basic wiring and switch.
 - Can-Am branded grill.
 - Can be installed on Can-Am Front Bumpers, Sport Roof and Bimini Roof.
 - Sold in pairs.
 - Not EC compliant.
 - Requires Light Power Cable.
- Maverick Trail, Maverick Sport**
715002935

BUILD YOUR LIGHTING SYSTEM. Refer to page 36

Some products shown may not be available or homologated in your country. Contact your BRP dealer for local details.

BUILD YOUR LIGHTING SYSTEM. Refer to page 36



BE SEEN WITH A HIGH-VISIBILITY ROOF TAIL LIGHT



BUILD YOUR LIGHTING SYSTEM IN 3 EASY STEPS

1. CHOOSE YOUR MOUNT POINT	2. CHOOSE YOUR LIGHTS							
	BAJA DESIGNS				CAN-AM			
	10" (25 CM) LED LIGHT BAR	XL SPORT LED LIGHTS (SOLD IN PAIRS)	SQUADRON SPORT LED LIGHTS (SOLD IN PAIRS)	XL80 LED LIGHTS (SOLD IN PAIRS)	10" (25 CM) DOUBLE STACKED LED BAR	15" (38 CM) DOUBLE STACKED LED BAR	39" (99 CM) DOUBLE STACKED LED BAR	4" (10 CM) ROUND LED (SOLD IN PAIRS)
	Consult p.34 for more information on these lights.				Consult p.35 for more information on these lights.			
TRAIL BUMPER & RANCHER BUMPER	NA	710005287 PLUS: 715002884 (Power Cable)	710004648 PLUS: 715002884 (Power Cable)	710005041 PLUS: 715003729 (Power Cable)	715002933 PLUS: 715003670 (Light Power Cable)	NA	NA	715002935 PLUS: 715003670 (Light Power Cable)
DRAGONFIRE FRONT BUMPER	NA	NA	NA	NA	715002933 PLUS: 715003670 (Light Power Cable)	NA	NA	715002933 PLUS: 715003670 (Light Power Cable)
ROOF (EXCEPT ALUMINUM DRAGONFIRE ROOF)	710004881 PLUS: 715002885 (Power Cable) *Optional: Overhead Switch Panel 715003669	710005287 PLUS: 715002884 (Power Cable) *Optional: Overhead Switch Panel 715003669	710004648 PLUS: 715002884 (Power Cable) *Optional: Overhead Switch Panel 715003669	710005041 PLUS: 715003729 (Power Cable) *Optional: Overhead Switch Panel 715003669	715002933 PLUS: 715003669 (Overhead Switch Panel)	715002934 PLUS: 715003669 (Overhead Switch Panel)	715004007 PLUS: 715003141 (Mounting Kit) *Optional: Overhead Switch Panel 715003669	715002935 PLUS: 715003669 (Overhead Switch Panel)
TOP ROLL CAGE & ALUMINUM DRAGONFIRE ROOF	NA	NA	NA	NA	NA	NA	715004007 PLUS: 715003141 (Mounting Kit)	NA

3. ORDER

ORDER ALL PART NUMBERS IN THE INTERSECTING BOX
 *NOTE: When installing more than one light kit, additional Light Power Cable or Mounting Kit is required.

*All lights are intended for Off-Road use only.

MOUNTING KIT FOR 39" (99 CM) LED LIGHT BAR
 (Not illustrated)
 - Required for installation of the 39" (99cm) double stacked LED light bar.
 - Includes wiring and support bracket.
Maverick Trail, Maverick Sport
 715003141

LIGHT POWER CABLE
 (Not illustrated)
 - Power cable for installation of compatible Can-Am light kits on Front Bumpers.
Maverick Trail, Maverick Sport
 715003670

BAJA DESIGNS LIGHT POWER CABLE
 (Not illustrated)
 - Required for installation of Baja Designs LED lights onto roof or bumper.
Maverick Trail, Maverick Sport
 715002885 - 10" (25 cm) Baja Designs OnX6 LED Bars
 715002884 - Baja Designs XL Sport LED Light & Baja Designs Squadron Sport LED Light
 715003729 - Baja Designs XL80 LED Light



LONESTAR RACING MOUNTS FOR 39" (99 CM) DOUBLE STACKED LED LIGHT BAR

- Low profile mounts allowing for the installation of the 39" (99 cm) Double Stacked LED Light Bar on the Lonestar Racing Aluminum Roof (sold separately).
Maverick Trail, Maverick Sport
 715004877



LED HEADLIGHTS ASSEMBLY
 - The headlights in this upgrade kit draw a maximum of 40W (2 x 20W) of power while providing brighter light output.
 - Lower power consumption and longer lasting than standard halogen bulbs.
Maverick Trail, Maverick Sport
 715003667

CAN-AM LED SIGNATURE LIGHTS
 - Add style with a more aggressive look.
 - Use bright and energy efficient LEDs.
 - Do not give additional lighting for driving.
 - Standard on DPS models.
Maverick Trail, Maverick Sport
 715003673

ROOF TAIL LIGHT
 - Roof mounted tail and brake light increases your visibility for following vehicles.
 - Uses bright and energy efficient LEDs.
 - Sport Roof (715003659) is required for installation.
Maverick Trail, Maverick Sport
 715003668

DOME LIGHT
 - LED array integrates perfectly with vehicle.
 - Wiring included.
 - Can be installed on cage, Sport Roof or All-Terrain Trunk Cover.
Maverick Trail, Maverick Sport
 715002455



Some products shown may not be available or homologated in your country. Contact your BRP dealer for local details.

INCLUDED RF WIRELESS REMOTE GIVES FULL CONTROL FROM STEERING WHEEL CRADLE

NEW COMPLETE WET SOUNDS AUDIO SYSTEM

- Orchestrated for outstanding sound quality and the playlists of champions.
- Built-in 200W amplifier with D-Bass Tech for improved low end bass response.
- Built-in Bluetooth connectivity with source control.
- Aux input allows for use with non-Bluetooth devices.
- Turns itself off after 10 minutes of inactivity to save battery power.
- Designed to be Can-Am-tough in the most demanding riding conditions.
- Includes 4.5" (11.4 cm) front and 6.5" (16.5 cm) rear-roll-cage mounted stereo speakers and console integrated backlit control panel.

Maverick Trail, Maverick Sport
715003672



WET SOUNDS STEALTH 6 ULTRA HD CAN-AM EDITION SOUND BAR

- Built in 200W amplifier with D-Bass Tech for improved low end bass response.
- Full range speaker array plus additional titanium dome tweeters for dynamic output and performance.
- HD High Output drivers with new composite high stiffness frames.
- Built-in Bluetooth connectivity with source control.
- RF wireless remote for full control from steering wheel cradle.
- Aux input allows for use with non-Bluetooth devices.
- Turns itself off after 10 minutes of inactivity to save battery power.
- Backlit control panel.
- 2V line-output allows for hooking up another sound bar or adding an external amplifier and speakers.
- IP67 rated for better protection against the elements.
- Powder coat finish for extra durability and resistance to the elements.
- Requires Sound Bar Mount Kit (715004745).

Maverick Trail, Maverick Sport
710006028

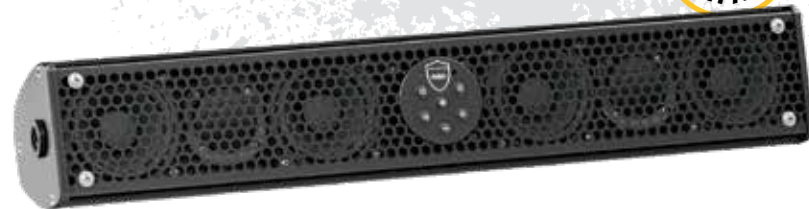

SOUND BAR MOUNT KIT

- (Not illustrated)
- Required Mount Kit for the Wet Sounds Stealth 6 Ultra HD Can-Am Edition Sound Bar (710006028).

Maverick Trail, Maverick Sport
715004745



STAY CONNECTED WITH YOUR MAVERICKS



RUGGED RADIOS CAR-TO-CAR SYSTEM

- Perfect for communicating with friends and family on group rides.
- Push-to-talk button conveniently mounted on the steering wheel.
- Includes radio mounting bracket, helmet speaker, mic kit and base charger.
- May be synched with the Rugged Radios Intercom System (715002891).
- 2-4 mile range.

This kit includes:

- RH-5R Rugged Radios 5-Watt Dual Band Handheld Radio
- Helmet Speaker/Mic Kit
- Push-to-talk buttons
- Mounting bracket
- Base station charger

Maverick Trail, Maverick Sport
715003440



RUGGED RADIOS INTERCOM SYSTEM

- Specifically designed to facilitate clear in-vehicle communication between driver and passenger(s).
- Expandable to 4 people.
- Includes music port for enjoying your favorite tunes.
- Seamless integration with in-dash switch panel.
- May be synched with the Rugged Radio Car-To-Car System (715003440).

Maverick Trail, Maverick Sport
715002891



OPTIMIZE YOUR RIDE EVEN IN COLDER CONDITIONS



NEW DEFROST, HEAT & VENTILATION SYSTEM

- Best integrated system on the market with 3-ventilation speed and in-dash adjustable temperature.
- Adjustable/directional vents.
- 5 vents specially positioned for better windshield defrosting and passenger comfort.
- Automotive-style heater core and fan for best heating performance.

Maverick Trail, Maverick Sport

715003678



GET YOUR HANDS ON OUTSTANDING FINGERTIP WARMTH



HEATED GRAB BAR COVER

- Made tough to hold up to the stresses of rough riding, this heated cover will keep your passenger's hands warm and securely gripped during long cold outings.
- Easy to install and remove.
- This kit includes the heated grab bar cover and in-dash switch.
- Heated Accessories Wiring Harness (710005757) is required.
- Draws a maximum of 25W and 1.8A at 13.5V.

Maverick Trail, Maverick Sport

715004500



HEATED STEERING WHEEL

- Ruggedly-constructed steering wheel designed to withstand cold conditions while channeling heat directly to your hands.
- Perfect for making hand mobility and grip readily available, e.g. hunting, manual farming.
- Replaces stock steering wheel.
- This kit includes the heated steering and in-dash switch.
- Heated Accessories Wiring Harness (710005757) is required.
- Draws a maximum of 45W and 3.2A at 13.5V.

Maverick Trail, Maverick Sport

715004283



HEATED SEAT COVER

- Made of rugged vinyl, this heated seat cover delivers chill-free riding comfort.
- Ergonomically designed to fit snugly over the seat, it is also easy to install and remove.
- High/Low temperature settings allow you to control the desired degree of warmth.
- This kit includes the heated seat cover and in-dash switch.
- Heated Accessories Wiring Harness (710005757) is required.
- Draws a maximum of 25W and 1.8A at 13.5V.

Maverick Trail, Maverick Sport

715004501



HEATED VISOR OUTLET

- Strategically positioned on vehicle to maintain your agility.
- Optional visor outlet that delivers fog-free riding.
- Quick and easy installation.
- Sold individually.
- Heated Visor not included.

Maverick Trail, Maverick Sport

715001246



HEATED ACCESSORIES WIRING HARNESS

(Not illustrated)

- Electric harness required to hook up and operate heated accessories.
- Power up to 4 accessories: 2 hand accessories (grab bar/steering wheel) and 2 seat covers.

Maverick Trail, Maverick Sport

710005757

LIGHT THE WAY WITH ULTRA-BRIGHT 5-COLOR WHIP FLAG

NEW ADJUSTABLE LIGHTED WHIP FLAG

- A must for riding the dunes.
- 5W Cree LED.
- 5 colored lenses to allow personalization.
- Glow-through whip, quickly-removable and replaceable pole.
- Increases vehicle's visibility.
- Meets most dune-area requirements.
- Die cast aluminum base, acetal hand nut.
- Includes adjustable mounting brackets and wiring.

Maverick Trail, Maverick Sport
715005437

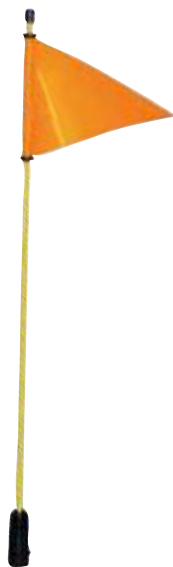

NEW BATTERY CHARGER/MAINTAINER

- Fully automatic 3 Amp battery charger / maintainer.
- Keeps stored lead-acid batteries charged.
- Charges and maintains small batteries.
- Microprocessor controlled multi-stage charging for added precision, safety and battery life.
- Automatically detects 6 or 12 volts batteries.
- Float mode monitoring automatically maintains optimum battery charge.
- Reverse hook-up protection helps protect battery and charger from damage.

715005061



NEW QUICK CONNECT BATTERY CABLE

(Not illustrated)

- Quickly and easily connect and charge different batteries with your charger.
- Included in the Battery Charger/Maintainer (715005061).
- Sold individually.

715005408

DIGITALLY ENCODED SECURITY SYSTEM (D.E.S.S.™) KEYS

- Top-security anti-theft protection for your vehicle.
- Encrypted chip technology restricts access to your vehicle's electronic ignition system.
- One vehicle/One code.
- A vibration/shock-resistant ball-and-socket design that ensures a reliable connection.
- Comes with 3 programmable keys:
 - Work key: limits vehicle speed to 40 kph (25 mph) but does not limit engine torque.
 - Normal key: limits vehicle speed to 70 kph (44 mph) and 50% torque reduction.
 - Performance key: No restrictions.

Maverick Trail, Maverick Sport
715002458



OVERHEAD SWITCH PANEL

- Fully integrated overhead switch panel gives additional switch spots for electrical accessories.
- Required for Can-Am lights installation on the roof and for other top-mounted electrical accessories.
- Optional for Baja Designs lights.
- Requires Sport Roof or Bimini Roof with Sun Visor for installation.

Maverick Trail, Maverick Sport
715003669



30AH BATTERY HOLDER

- Fixation plate designed to hold the 30ah Battery.
- 30ah Battery (515176151) sold separately.

Maverick Trail, Maverick Sport
715004431



DUAL MODE SWITCH

- Switches quickly and conveniently between normal and eco modes.
- Eco mode increases fuel economy.
- In-dash plug-and-play mount.
- Standard on DPS models.

Maverick Trail, Maverick Sport
715004736



12V POWER OUTLET

- 12 V accessories outlet.
- Easy plug-in harness included.

Maverick Trail, Maverick Sport
715003846



NEW USB POWER OUTLET KIT

- Recharges your electronic devices while riding* (smartphone, MP3, heating gear, etc.).
- Dual port USB connectors.
- * The power outlet is not capable of recharging all device types while riding.

Maverick Trail, Maverick Sport
219400510



GARMIN MONTANA® 680T GPS

- Rugged and waterproof, the Montana 680T is element-proof.
- 4-inch dual-orientation, sunlight-readable touchscreen and glove-friendly touchscreen display, to give you vivid colors and high-resolution images.
- 8-megapixel autofocus camera automatically geotags photos.
- Tracks both GPS and GLONASS satellites for improved positioning and typically faster fixes.
- Preloaded TOPO maps, plus 1-year BirdsEye Satellite Imagery subscription.
- 3-axis compass with barometric altimeter.
- Specific GPS cradle included (vehicle mounting kit required).
- Includes a preloaded map for US.

Maverick Trail, Maverick Sport
715002830

European Version

- EC compliant.
- Includes preloaded European recreation map.

715003456



RAM GPS MOUNT

- Allows for GPS integration onto vehicle.
- Standard AMPS hole pattern for Garmin Cradle.

Maverick Trail, Maverick Sport
715003325



CGX3 CAMERA

- 160° wide angle lens.
- Resolution options: from 3MP up to 20MP and VGA.
- Video resolutions available: 2.7K at 30 frames per second (FPS), 720P at 120/60/30 FPS, 1080P at 60/30 FPS and VGA at 240 FPS.
- Record videos in 4K UHD at 24 FPS, 2.7K QHD at 30 FPS and 720P at 120 FPS.
- Memory: Class 10 32GB Micro SD card.
- 2" (5 cm) capacitive touchscreen.

9700130090

- Li-ion battery capacity of 1050mAh, working time of 1/1.5 hours and charging time of 3 hours (2 batteries included).
- WiFi function remotely operates up to 10-15 meters with mobile devices and Cyclops app for Android and IOS.
- Waterproof up to 10 meters without a case.
- Features modes such as invert, time lapse, high speed and loop recording, motion detection, capture (while recording a video), burst and anti-sharing.
- Comes with 8 mounting accessories.



CGX3 GIMBAL CAMERA STABILIZER

(Not illustrated)

- 3-axis Full 360-degrees precision: Eliminates shaky video and allows you to easily shoot pro-quality, cinematic-like footage with your Action Camera.
- Independent APP to control the gimbal.

9700160090

- Built-in Bluetooth 4.0.
- Compatible with IOS 8.0 and Android 4.4 or above.
- Rechargeable battery.
- Rugged, full Aluminum Alloy.
- 5-way joystick and multi-function button for flexible operations and convenient switch.

CGX3 POWER STICK MOUNT

(Not illustrated)

- Includes power hand grip, long screw, convert tripod mount, phone clip mount, USB mini cord, USB micro cord and adjustable strap.

9700100090

CGX3 LED LIGHT

(Not illustrated)

- Wide-Angle 300 Lumen Max. (5500K-6000K) by 3 LEDs.
- Waterproof, attachable light
- Three modes of light: High, Low, Flashing
- Rechargeable Battery: 1050mAh.

9700200090

CGX3 SELFIE STICK

(Not illustrated)

- Easily take photos or record videos with the CGX3 Selfie Stick.
- This selfie stick is made tough for any sport or activity.

9700170090

WARN⁺ PROVANTAGE

- Patented roller disc brake for enhanced winching control.
- Ergonomic clutch handle.
- Three-stage planetary gear train for smooth, efficient operation.
- All-metal gear housing and gears.
- Fully sealed motor and drive train keep the elements out.
- Weather sealed corded remote and dash mounted switch.
- Limited lifetime warranty for mechanical components and 3-year warranty for electrical components.
- EC compliant.

WARN PROVANTAGE 4500-S WINCH

- Pulling strength capability of 4,500 lb (2,041 kg).
- 50 ft. of 7/32" (15.2 m of 5.5 mm) synthetic rope.
- Double-powder-coated hawse fairlead.
- Winch Electrical Harness (715003777) required for installation on Base and DPS models.

Maverick Trail, Maverick Sport

715002941



WARN PROVANTAGE 4500 WINCH

- Pulling strength capability of 4,500 lb (2,041 kg).
- 55 ft. of 7/32" (16.8 m of 5.5 mm) wire steel cable.
- Roller fairlead.
- Winch Electrical Harness (715003777) required for installation on Base and DPS models.

Maverick Trail, Maverick Sport

715002425



CAN-AM TERRA BY SUPERWINCH⁺

- Ergonomic clutch handle.
- Automatic 100% load-holding brake.
- Rugged all-steel gears and bushings for more torque and durability.
- Sealed solenoid for all-weather protection.
- Weather sealed corded remote and dash mounted switch.
- EC compliant.

CAN-AM TERRA 45 WINCH BY SUPERWINCH

- Pulling strength capability of 4,500 lb (2,041 kg).
- 47 ft. of 1/4" (14.3 m of 6.3 mm) wire steel cable.
- Heavy-duty 4-way roller fairlead.
- Winch Electrical Harness (715003777) is required for installation on Base and DPS models.

Maverick Trail, Maverick Sport

715002838



CAN-AM TERRA 45SR BY SUPERWINCH

- Pulling strength capability of 4,500 lb (2,041 kg).
- 50 ft. of 3/16" (15.2 m of 4.8 mm) synthetic rope.
- Corrosion-proof aluminum hawse fairlead.
- Winch Electrical Harness (715003777) is required for installation on Base and DPS models.

Maverick Trail, Maverick Sport

715004446



SUPERWINCH HAWSE FAIRLEAD

- A must when upgrading your winch with a synthetic cable, this corrosion-proof aluminum hawse fairlead will prevent the cable from snapping in a corner of a roller fairlead and from wearing prematurely due to the rough surface of the worn roller guide.
- Must be used with synthetic cables only.

SuperWinch winch

715004449



WARN HAWSE FAIRLEAD

- Double powder coated construction.
- Required to use the Synthetic Winch Cable (715001118) on Warn winches.
- To be used with synthetic winch cables only.

705204567



SUPERWINCH WIRED REMOTE CONTROL

- This kit allows winch owners to add the hand-held remote to vehicles with a stock SuperWinch.
- OEM stock winch and Wired Remote Control are sold separately.
- EC compliant.
- Harness 710004823 is required to use remote control on a vehicle with a factory installed winch.

with Superwinch winch

710004887



WARN WIRED REMOTE CONTROL

- This kit allows winch owners to add the hand-held remote to their stock winch.
- Harness 710004823 is required to use remote control on a vehicle with a factory installed winch.

With Warn winch

710001002



WIRELESS REMOTE CONTROL

- The system is quick and easy to install, thanks to a wiring harness with an integrated antenna and all necessary mounting hardware.
- Allows you to operate your winch from anywhere within a 50' (15.2 m) radius, increasing your recovery options.
- All components are weatherproof.

with Warn winch

715002542



WINCH ELECTRICAL HARNESS

- (Not illustrated)
- Required for winch installation on Base and DPS models.

Maverick Trail, Maverick Sport
715003777

SYNTHETIC WINCH CABLE

- 50' of 7/32" (15.2 m of 5.5 mm) synthetic cable for Warn winch.
- Warn Hawse Fairlead (705204567) is required when upgrading to a synthetic cable to avoid damage and premature wear of the cable.

with Warn winch

715001118

- 50 ft. of 3/16" (15.2 m of 4.8 mm) synthetic cable for SuperWinch winches.
- SuperWinch Hawse Fairlead (715004449) required when upgrading to a synthetic cable to avoid premature cable damage and wear.

with SuperWinch winch

715004448



FRONT RECEIVER HITCH

- Heavy-duty 1,500 lb (680 kg) towing capacity 2" (5 cm) receiver hitch.
- Perfect for precision towing in small spaces.

Maverick Trail, Maverick Sport

715003642



SYNTHETIC CABLE EXTENSION

- Lightweight 1/4" (6.3 mm) diameter, easy to handle and won't rattle in cargo box.
- Easily attaches to winch cable to provide additional 50' (15.2 m) of distance.
- 4,500 lb (2,041 kg) single line capacity.

715001120



WIRE ROPE REPLACEMENT

- 55' of 7/32" (16.8 m of 5.5 mm) wire rope for Warn winch kit.

with Warn winch

715001117

- 47 ft. of 1/4" (14.3 m of 6.3 mm) wire rope.
- 4,500 lb (2,041 kg) pulling strength.

with SuperWinch winch

705011595





YOSHIMURA SLIP-ON EXHAUST

- Developed in collaboration with Yoshimura.
- Made from 304-grade Stainless Steel.
- Sporty sound from a lighter than stock muffler.

Maverick Trail, Maverick Sport (except DPS 1000R)
715003716

- USDF/USDA approved spark arrester.
- EPA compliant.
- Not EC compliant.



FOAM AIR FILTER BY TWIN AIR®

- The best choice for the harshest conditions.
- Multiple staged oiled filtering foam for superior dust retaining capacity with high air flow.
- Washable and reusable.

Maverick Trail, Maverick Sport (except 1000R models)
715003630



ENGINE & CVT PRE-FILTER KIT

- (Not illustrated)
- Adds extra protection to your engine and CVT in harsh riding condition.
- Filter blocks particles larger than 0.005" (0.1 mm).
- Water repellent screen.
- Necessary to maintain the vehicle's warranty when tracks are installed.
- Recommended for winter riding conditions.

Maverick Trail, Maverick Sport
715004290

SHOCK COVERS

- (Not illustrated)
- Soft cover for shocks with ventilation holes.
- Eliminate dust and dirt intrusion into the shock cylinder, reducing risk of damage.
- Sold in pairs.

Maverick Sport
715002368



S&B PARTICLE SEPARATOR

- Use vortex generators to eject approximately 94% of the dust, snow, or silt before it even reaches your airbox.
- Help maintain power, protect your engine and dramatically extend the life of your filter.
- Cage mounted with adjustable clamps.

Maverick Sport 1000R
715004902 **NEW**

Maverick Trail, Maverick Sport (except 1000R)
715004422



EJECTS DUST, SNOW, AND SILT BEFORE IT CAN REACH YOUR FILTER



APACHE BACKCOUNTRY TRACK SYSTEM

APACHE TRACK SYSTEMS: THE PERFECT FIT

Highly engineered track system provides ultimate traction in harsh conditions for your Can-Am vehicle.

Heavy-duty components ensure reliability and the design offers excellent acceleration, turning, braking and side-hilling performance.

An innovative DPS module ensures speedometer accuracy and an optimized steering assist for use with tracks which make for a perfect control and riding ease.

Some products shown may not be available or homologated in your country. Contact your BRP dealer for local details.

APACHE BACKCOUNTRY TRACK SYSTEM



Efficient frame and rail design ensures weight is evenly distributed on snow.

Easy-to-operate snowmobile-type sliding tensioner

Largest contact patch anywhere: **23% more** than the Apache 360 LT

APACHE™ BACKCOUNTRY TRACK SYSTEM

- Designed to deliver the best flotation level and deep-snow performance on the market.
- Contact patch is 23% bigger than the Apache 360 LT.
- Provides an impressive average ground clearance increase of 7" (18 cm), keeps the vehicle out of deep snow.
- Aggressive track design with 2" (5 cm) lug height for maximum traction on snow.
- Apache Backcountry Mounting Kit and Engine & CVT Pre-Filter Kit (715004290) are required.
- For winter use only.

Maverick Trail, Maverick Sport
715005247

AVAILABLE AT YOUR LOCAL DEALERSHIP IN SEPTEMBER 2018.

WINTER TRACKS

Can-Am's new **APACHE BACKCOUNTRY TRACK SYSTEM** is the perfect fusion of BRP's renowned snowmobile and innovative Apache 360 Track System technologies. It delivers the highest ground clearance, the most flotation, and the best deep-snow performance of any ATV track kit on the market today. Period. An efficient frame and rail design ensures weight is spread evenly on snow so you always enjoy higher traction, remarkable acceleration, turning, braking and side-hilling. And it's the only kit available with a 13.5" X 96" [34 cm x 244 cm] front track / 14" X 138" [36 cm x 351 cm] rear track, which adds up to the largest contact patch anywhere.



NEW APACHE BACKCOUNTRY MOUNTING KIT

- (Not illustrated)
- Required for installation of the Apache Backcountry Track System.
- Track DPS module and Pre-Filter not included.

Maverick Trail, Maverick Sport
715004285

AVAILABLE AT YOUR LOCAL DEALERSHIP IN SEPTEMBER 2018.

IDLER WHEEL KIT

- Reduces drag and rolling resistance.
- Includes 2 wheels, brackets and hardware.
- Add up to 2 kits per rear track.
- Can extend slider life in hardened snow conditions.

Apache Backcountry Track System, rear tracks only
860201230 • 141 mm



SLIDERS WITH VESPEL[†] INSERTS

- Use DuPont Vespel inserts for less friction.
- Longer life.
- Can be cut to desired length.
- 8 needed per vehicle.
- Sold individually.

Apache Backcountry Track System
503194815



APACHE 360 LT TRACK SYSTEM



Rubber over molded heavy-duty double bearing wheels and offset wheel spacing reduce friction and vibration while ensuring reliability.

Total ground surface area of 2291,5 in² [14 784 cm²]

Added ground clearance of 4,5" [11,4 cm]

Quick & easy installation



Unique adjustable contact patch system to tackle the toughest year-round conditions.

APACHE 360 LT TRACK SYSTEM

- Multifunctional tracks designed to support heavy loads and to fit on most Can-Am off-road vehicles.
- Extra contact patch adjustment for better performance over rough terrain.
- Contact patch is 7 to 9% bigger than the Apache 360's.
- Average ground clearance of 17.3" (44 cm).
- 1" (2.5 cm) lugs in the front and 1.25" (3.2 cm) in the back.
- Apache 360 LT Mounting Kit and engine & CVT air intake pre-filters (715004290) are required.

Maverick Trail, Maverick Sport
715003064

AVAILABLE AT YOUR LOCAL DEALERSHIP IN SEPTEMBER 2018.

YEAR-ROUND TRACKS

The **APACHE 360 LT TRACK SYSTEM** provides a unique adjustable contact patch that enables you to tackle the toughest conditions year round. You can choose a better attack angle in rough terrain or greater flotation in **deep snow**. Super versatile and ideal in springtime as well, when the **ground is muddy and soft**, allowing you to work and play on your terrain without damaging it. Some users love them in very **humid or swampy lands**, to help maintain a better ground adhesion all season round.



APACHE 360 LT MOUNTING KIT

- (Not illustrated)
- Required for installation of the Apache 360 LT Track System.
- DPS module and Pre-Filter not included.

Maverick Trail
715004833

Maverick Sport
715004755

AVAILABLE AT YOUR LOCAL DEALERSHIP IN SEPTEMBER 2018.

TRACK DPS MODULE

- (Not illustrated)
- Innovative DPS module that ensures speedometer accuracy and optimized steering assist which make for perfect track control and riding ease.
- Required to install the Apache Track Systems.

Maverick Trail, Maverick Sport
715004707

AVAILABLE AT YOUR LOCAL DEALERSHIP IN SEPTEMBER 2018.

COMPETITIVE, RUGGED & EFFECTIVE.

The all-new Can-Am ProMount Plow Kits are here to take on winter. Whether it's a large commercial lot or a short driveway, this is how to get the job done right. Better, simpler, and with the same Can-Am reliability & durability you expect.

NEW CAN-AM PROMOUNT PLOW SYSTEM

CAN-AM PROMOUNT FLEX2 60" (152 CM) PLOW KIT

Maverick Trail, Maverick Sport

■ 715005202 - Black



KIT INCLUDES:

- Can-Am ProMount Flex2 60" (152 cm) Blade
715004203 - Black
- Can-Am Promount Push Frame with Quick-Attach System
715004339
Also sold individually on p.52
- Can-Am ProMount Mounting Plate
715004338
Also sold individually on p.52

ALSO SOLD INDIVIDUALLY:

CAN-AM PROMOUNT FLEX2 60" (152 CM) BLADE

- Plow blade made of UHMWPE, flexible and impact absorbing material prevents damaging your plow when accidental impact occurs.
- Replaceable wear blade.
- Blade swivels left or right, 5 positions.
- Large pin designed for easy blade rotation to eliminate dirt and snow buildup at pivot point.
- Blade design provides best snow/dirt roll-off at any angle.
- Compatible with Can-Am ProMount Blade accessories to further enhance plow versatility.
- Clears 54" (137 cm) when plow is fully angled.
- Blade height of 17" (43 cm).

■ 715004203 - Black



Can-Am
ProMount Steel
66" (168 cm)
Plow Kit

THERE'S A PLOW FOR EVERY TYPE OF USER AND EVERY TYPE OF USE.

- > Flexible and built to last, the **Can-Am ProMount Flex2 Blade** is the perfect solution for driveways, storefronts and any area that needs clearing quickly & efficiently.
- > Those looking for a range of widths will appreciate no-nonsense practicality of our **Can-Am ProMount Steel Blades**. Each is designed to put competing plows to shame and both are every bit as tough as the road is long.

CAN-AM PROMOUNT STEEL 60" (152 CM) PLOW KIT

Maverick Trail, Maverick Sport

■ 715005201 - Black
■ 715005434 - Yellow



KIT INCLUDES:

- Can-Am ProMount Steel 60" (152 cm) Blade
715004202 - Black
or
715005317 - Yellow
- Can-Am Promount Push Frame with Quick-Attach System
715004339
Also sold individually on p.52
- Can-Am ProMount Mounting Plate
715004338
Also sold individually on p.52

ALSO SOLD INDIVIDUALLY:

CAN-AM PROMOUNT FLEX2 60" (152 CM) BLADE

- Plow blade made of UHMWPE, flexible and impact absorbing material prevents damaging your plow when accidental impact occurs.
- Blade swivels left or right, 5 positions.
- Large pin designed for easy blade rotation to eliminate dirt and snow buildup at pivot point.
- Blade design provides best snow/dirt roll-off at any angle.
- Compatible with Can-Am ProMount Blade accessories to further enhance plow versatility.
- Clears 54" (137 cm) when plow is fully angled.
- Blade height of 17" (43 cm).

■ 715004202 - Black
■ 715005317 - Yellow



CAN-AM PROMOUNT STEEL 54" (137 CM) PLOW KIT

Maverick Trail, Maverick Sport

■ 715005200 - Black
■ 715005428 - Yellow



KIT INCLUDES:

- Can-Am ProMount Steel 54" (137 cm) Blade
715004472 - Black
or
715005316 - Yellow
- Can-Am Promount Push Frame with Quick-Attach System
715004339
Also sold individually on p.52
- Can-Am ProMount Mounting Plate
715004338
Also sold individually on p.52

ALSO SOLD INDIVIDUALLY:

CAN-AM PROMOUNT STEEL 54" (137 CM) BLADE

- Plow blade made from 12-gauge steel.
- Replaceable wear blade.
- Blade swivels left or right, 5 positions.
- Large pin designed for easy blade rotation to eliminate dirt and snow buildup at pivot point.
- Blade design provides best snow/dirt roll-off at any angle.
- Compatible with Can-Am ProMount Blade accessories to further enhance plow versatility (except for Can-Am ProMount Steel 54" (137 cm) Blade (715004472)).
- Clears 50" (127 cm) when plow is fully angled.
- Blade height of 14.75" (37 cm).

■ 715004472 - Black
■ 715005316 - Yellow



CAN-AM PROMOUNT STEEL 66" (168 CM) PLOW KIT

Maverick Trail, Maverick Sport

■ 715005427 - Black
■ 715005435 - Yellow



KIT INCLUDES:

- Can-Am ProMount Steel 66" (168 cm) Blade
715004473 - Black
or
715005318 - Yellow
- Can-Am Promount Push Frame with Quick-Attach System
715004339
Also sold individually on p.52
- Can-Am ProMount Mounting Plate
715004338
Also sold individually on p.52

ALSO SOLD INDIVIDUALLY:

CAN-AM PROMOUNT STEEL 66" (168 CM) BLADE

- Plow blade made of UHMWPE, flexible and impact absorbing material prevents damaging your plow when accidental impact occurs.
- Blade swivels left or right, 5 positions.
- Large pin designed for easy blade rotation to eliminate dirt and snow buildup at pivot point.
- Blade design provides best snow/dirt roll-off at any angle.
- Compatible with Can-Am ProMount Blade accessories to further enhance plow versatility.
- Clears 60" (152 cm) when plow is fully angled.
- Blade height of 17" (43 cm).

■ 715004473 - Black
■ 715005318 - Yellow



NEW

CAN-AM PROMOUNT MOUNTING PLATE & PUSH FRAME

The all-new Universal Push Frame and Plow Mounting Kit offers seamless compatibility between our next-generation plastic and steel blades and our Maverick Trail and Maverick Sport models.

CAN-AM PROMOUNT MOUNTING PLATE

- Required to install the Can-Am ProMount Push Frame with Quick-Attach System.
- Mounting plate precision-designed to stay on year round without compromising ground clearance.
- Fits with or without Can-Am Skid Plates.

Maverick Trail, Maverick Sport
715004338



CAN-AM PROMOUNT PUSH FRAME WITH QUICK-ATTACH SYSTEM

- Heavy-duty steel tubes designed to withstand the roughest use.
- Mid-mount carriage provides ultimate push strength and traction.
- Allows 14" (36 cm) of plow lift.
- Features a self-aligning quick-attach system, an easy foot release pedal and an ergonomic handle for plow angle adjustment.
- Compatible with all Can-Am ProMount Blades.
- Plow Roller Fairlead and Plow Limit Switch recommended to extend winch cable lifespan.
- Can-Am ProMount Mounting Plate required for installation.

Maverick Trail, Maverick Sport
715004339



CAN-AM PROMOUNT PUSH FRAME EXTENSION

- 12" (30 cm) push frame extension required when plow is installed with Apache Track systems.

Maverick Trail, Maverick Sport
715004204

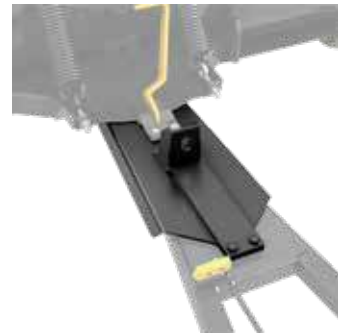

PLOW ACCESSORIES

CAN-AM PROMOUNT EDGE MARKERS

- Help locate the edges of your plow.
- Height: 24" (60 cm)
- Sold in pairs.
- Recommended for Maverick Sport and Maverick Trail.

Maverick Trail, Maverick Sport
715004206

PLASTIC WEAR BLADE

- Ideal to prevent leaving marks on your driveway.

Maverick Trail, Maverick Sport

Can-Am ProMount 54" (137 cm) Plastic Wear Blade	Can-Am ProMount 60" (152 cm) Plastic Wear Blade	Can-Am ProMount 66" (168 cm) Plastic Wear Blade
715004480	715004481	715004482



CAN-AM PROMOUNT BLADE EXTENSIONS

- These conveniently extend your Can-Am ProMount Blade.
- Add 3" (8 cm) each side.
- Compatible with Can-Am ProMount Blades (except for Can-Am ProMount Steel 54" (137 cm) Blade).
- Longer Wear Blade can be installed to go over the extra length given by the extensions.

Maverick Trail, Maverick Sport

- 715004205 - Black
- 715005319 - Yellow

CAN-AM PROMOUNT DRIFT CUTTERS

- Help keep snow in the plow.
- Dimensions: 17" x 13" (43.2 cm x 33 cm).
- Sold in pairs.
- Compatible with Can-Am ProMount Blades with or without extensions (except for Can-Am ProMount Steel 54" (137 cm) Blade (715004472)).

Maverick Trail, Maverick Sport
715004207

PLOW ROLLER FAIRLEAD

- Larger diameter lower roller reduces wear on wire rope for plow application.
- Can be used with all ProMount plows.

Maverick Trail, Maverick Sport
705009222



PLOW LIMIT SWITCH

- (Not illustrated)
- For controlling the cable tension when over raising your plow system.
- Prevents winch, plow push frame and vehicle damage.

Maverick Trail, Maverick Sport
715004775

TRAILERING COVER

- Weather-resistant trailering cover protects your vehicle during storage and transportation.
- Heavy-duty canvas made of UV-resistant solution-dyed polyester.
- Inner soft liner protects windshield and colored panels from abrasion.
- All high abrasion areas are reinforced with a double canvas layer.
- Opening for fuel cap.
- Quick and easy installation.
- Designed to perfectly fit your vehicle with or without Can-Am accessories.

Maverick Trail, Maverick Sport

715003706



BOLT-ON† RETRACTABLE RATCHETING TIE-DOWNS

- Perfect for transporting your powersport vehicle or securing loads.
- Mounts easily. Bolts on any flat surface (e.g. truck bed or frame).
- 1" x 6' (2.5 cm x 1.8 m) tie-down strap with heavy-duty stitching that delivers a 500 lb (226 kg) working load strength and 1500 lb (680 kg) break strength.
- Convenient retractable push button automatically slackens, spools and stores away strap, while the ratchet mechanism tightens the strap snugly to secure your vehicle or load into place.
- Rubber ratcheting handle provides firm grip, and the hook is vinyl coated to protect whatever surface it hooks into.
- Sold in pairs.

295100737



RATCHETTIE-DOWNS

- 400 lb (181 kg) safe working load.
- 1" x 10' (2.5 cm x 3 m) strap with Sea-Doo, Ski-Doo and Can-Am logos.
- Deluxe ratchet with rubber handle.
- Coated S hooks.
- Pack of 2.

860200447 - Black/Grey



TIRES & RIMS



CARLISLE ACT TIRE

Maverick Trail, Maverick Sport

Front - 705402313 26" x 8" x 12"	Rear - 705402314 26" x 9" x 12"
-------------------------------------	------------------------------------



12" MAVERICK TRAIL RIM

- Matching Nuts - 250100042.
- 12" x 6" - Offset = 41 mm

Maverick Trail, Maverick Sport
705401217



12" MAVERICK TRAIL DPS RIM

- Matching Nuts: 250100184 (Black).
- Matching Cap: 705400928.
- 12" x 6" - Offset = 41 mm

Maverick Trail, Maverick Sport
705401417



Some products shown may not be available or homologated in your country. Contact your BRP dealer for local details.

SPORTSWEAR & RIDING GEAR





NEW ZIPPED HOODIE

- Full-zip hooded sweatshirt.
- Ribbed waistband and cuffs.
- 60% Cotton, 40% Polyester Fleece
- Can-Am print in hood liner.
- High-density logo at front.
- 2 hand warmer pockets.
- Woven label at pockets.

454080 - S, M, L, XL, 2XL, 3XL - Blue (80), Black (90)



NEW CAN-AM PULLOVER HOODIE

- Lightweight cotton hoodie.
- Printed logo at sleeve.
- Woven label at hem.
- 60% Cotton, 40% Polyester

454079 - S, M, L, XL, 2XL, 3XL - Charcoal Grey (07)



NEW ORIGINAL TEE

- Cotton tee with discharge print logo and woven label at back.
- 100% Cotton

454068 - XS, S, M, L, XL, 2XL, 3XL - White (01), Black (90)



NEW INTRUSION TEE

- Cotton tee with screen print logo and woven label at back.
- 100% Cotton

447373 - XS, S, M, L, XL, 2XL, 3XL - Black (90), Amber (95)



NEW X-TEAM TEE

- Cotton tee with screen print logo at front and back.
- Woven label at side.
- 100% Cotton

454069 - XS, S, M, L, XL, 2XL, 3XL - Blue (80), Black (90)



NEW TECHNICIAN SHIRT

- Yarn dyed twill shirt.
- Patch logos at front.
- Pleat at center back.
- Chest pocket with zipper.
- 60% Cotton, 40% Polyester

454074
S, M, L, XL, 2XL, 3XL
Blue (80), Black (90)



NEW LONG SLEEVE ORIGINAL TEE

- Cotton tee with discharge print logo and woven label at back.
- 100% Cotton

454085
S, M, L, XL, 2XL, 3XL
White (01), Black (90)



NEW LADIES' ORIGINAL TEE

- Cotton tee with discharge print logo and woven label at back.
- Feminine cut.
- 95% Cotton, 5% Spandex

454071
XS, S, M, L, XL, 2XL
White (01), Black (90)



NEW LADIES' X-TEAM TEE

- Cotton tee with screenprint logo and woven label at side.
- Pocket at front.
- 95% Cotton, 5% Spandex

454070
XS, S, M, L, XL, 2XL
Turquoise (Aqua) (76),
Black (90)



58 CAN-AM SPORTSWEAR

NEW INTRUSION CAP

- Adjustable plastic strap.
- Cotton canvas at front.
- Embroidered logos at front.
- Mesh at back.

55% Cotton, 45% Polyester

447370 • One size
Charcoal Grey (07),
Black (90)



NEW INTRUSION FLAT CAP

- Adjustable plastic strap.
- Cotton canvas.
- Logo embroidered at front.
- Woven label at back.
- Screen print under brim.

100% Cotton

447383 • One size
Blue (80)



NEW FLAT EDGE CAP

- Adjustable plastic strap.
- Flat peak.
- Cotton canvas at front.
- Mesh at back.

55% Cotton, 45% Polyester

447646 • One size
Black (90)



NEW CLASSIC CAP

- Adjustable plastic strap.
- Embroidered 3D logo at front.
- 100% Cotton

448522 • One size • Grey (09), Red (30), Blue (80), Navy (89), Black (90)

- Woven label at back.
- Screen print under brim.



NEW ADVENTURE TEAM JERSEY

- Quick-dry, antibacterial moisture-wicking fabric.
- Extended back for coverage while riding.
- Mesh fabric for extra ventilation underarms.
- Non-fading sublimated graphics.
- Rib cuffs.

100% Polyester

454072 • S, M, L, XL, 2XL, 3XL • Grey (09), Red (30)

NEW X-RACE JERSEY

- Ultralight, quick-dry, antibacterial and moisture-wicking fabric.
- Mesh fabric for maximum breathability.
- Extended back for coverage while riding.
- Non-fading sublimated graphics.
- Rib cuffs.

100% Polyester

454073 • S, M, L, XL, 2XL, 3XL • Charcoal Grey (07), Blue (80)



MUD GEAR

MUD JACKET

- 100% waterproof PVC.
- Electronically-welded seams.
- Underarm and rear vent panels.
- 2 hand pockets.

Polyvinyl Chloride (PVC)

286676 • S, M, L, XL, 2XL • Clear (00), Matte Black (93)



MUD PANTS

- Oversized pants made of 100% waterproof PVC.
- Electronically-welded seams.
- Strategically placed ventilation.
- Side openings at bottom leg.

Polyvinyl Chloride (PVC)

286128 • S, M, L, XL, 2XL • Clear (00), Matte Black (93)



NEW LADIES' TEAM JERSEY

- Semi-fitted cut specifically designed for ladies.
- Quick-dry, antibacterial, moisture-wicking fabric for maximum comfort.
- Mesh fabric for extra ventilation underarms.
- Rib cuff.
- Non-fading sublimated graphics.

90% Polyester, 10% Spandex

454134 • XS, S, M, L, XL, 2XL • Grey (09), Teal (74)



Some products shown may not be available or homologated in your country. Contact your BRP dealer for local details.



ENDURO DESIGNED FOR LONG RIDES AND HIGH ADVENTURE.

Features & Benefits

Perfect for adventure riding, on or off the trails. The EX-2 offers the dual experience of riding with a visor helmet plus the look and advantages of an MX helmet.

- Advanced plastic composite shell.
- Lockable, multi-positions and anti-scratch visor.
- Interchangeable retractable sun visor.
- Removable aerodynamic peak.
- Ultra-comfort and washable Dri-Lex⁺ linings.
- Oversized chin deflector.
- Adjustable air vents and exhausts.

EX-2 ENDURO HELMET

Shell: Polycarbonate Composite

448466

XS, S, M, L, XL, 2XL
Black with graphics (94)

DOT ECE22.05



XP-3 SUPERLIGHT CROSS-STYLE HELMET: FEATURE-PACKED FOR EXCEPTIONAL PERFORMANCE, PROTECTION AND COMFORT.

Features & Benefits

- Premium shell construction using superlight fiberglass and impact absorbing EPS liner.
- Aero-tuned fully adjustable visor system.
- Custom stainless grille design.
- Front and rear hi-max air vent system to maximize cooling.
- Removable, washable and replaceable CoolMax™ moisture-wicking liner.
- Lightweight double-D chin strap.
- Weight: ±1470 grams for size Large.
- Durable multi-colored clear coated graphics.
- Can-Am branded.
- Triple certified: DOT, ECE and SNELL M2015.

NEW XP-3 PRO X-RACE HELMET

Shell: Fiberglass

448537

XS, S, M, L, XL, 2XL
White (01), Gold (11)

DOT Snell ECE22.05



XC-4 PREMIUM LOOK & STYLE.

Features & Benefits

- Shell construction is super light polycarbonate with impact absorbing EPS liner.
- Fully adjustable visor system.
- Custom stainless grille design.
- Front and rear hi-max air vent system to maximize cooling.
- Removable, washable and replaceable moisture-wicking liner.
- Lightweight double-D chin strap.
- Weight: ±1470 grams for size Large.

NEW XC-4 MODERN HERITAGE HELMET

- Durable multi-colored clear coated graphics.
- Can-Am branded.

Shell: Polycarbonate Composite

448526

XS, S, M, L, XL, 2XL
White (01), Grey (09)

DOT ECE22.05



XC-4 HELMET

Shell: Polycarbonate Composite

448255

XS, S, M, L, XL, 2XL
Black (90)

DOT Snell



LADIES' XC-4 HELMET

- Durable multi-colored clear coated graphics.
- Winter breath deflector included.

Shell: Polycarbonate Composite

448397

XS, S, M, L, XL, 2XL
Pink (36)

DOT ECE22.05



DUST MASKS

- Easily replaceable filters remove 99.9% of airborne dust, particles, pollen and odors.
- Made from soft yet durable neoprene material that fits snugly under helmets and goggles.
- XS/S fits most kids 12 and under, M/L fits most riders and XL/2XL fits larger frames (235+ lb).
- Includes 2 replacement filters and a small storing pouch.



NEW CAN-AM ORIGIN DUST MASK

- Convenient MP3 player pocket on the side.

448524

XS/S, M/L, XL/2XL
Black with graphics (94)



NEW CAN-AM VENTED DUST MASK

448525

XS/S, M/L, XL/2XL
Black (90)

COMMUNICATION SYSTEM

NEW SENA 30K BLUETOOTH COMM SYSTEM

- Bluetooth headset that operates on Sena's Mesh Intercom™ technology.
- The 30K has a new quick charge feature meaning just 20 minutes of charging gets riders an impressive 5 hours of Bluetooth intercom use, or 3 hours Mesh Intercom use.
- 2.4 GHz frequency, connecting to other riders in an entirely new way.
- Should one of the group's riders go out of range, the Mesh Intercom intelligently keeps the rest of the group in seamless communication, while actively searching to reconnect, should that rider come back within range.
- Using the private group mode, the 30K can pair in full duplex communication with up to 16 riders at a range up to 1.2 miles.
- Sena 30K Audio Multitasking technology allows you to have a conversation via Adaptive Mesh-Networking technology while simultaneously enjoying Bluetooth operations such as streaming smartphone music, taking or making phone calls, or listening to turn-by-turn GPS navigation.

Single Pack

448610

One size

Black (90)

Dual Pack

448611

One size

Black (90)



*Some models and accessories shown may not be available or homologated in your country. Contact your BRP dealer or local authorities for information.

GOGGLES

CAN-AM RACE SAND GOGGLES BY SCOTT

- No Fog[®] anti-fog lens treatment.
- 100% UV protected grey Lexan[®] lens.
- Dust catcher vent foam.
- Multi-layer face foam.
- Durable anti-slip strap.
- Tear-off and roll-off compatible (sold separately).
- Extra clear lens in the box.

448491 · One size · Black (90)



CAN-AM TRAIL GOGGLES BY SCOTT

- 100% UV protected clear Lexan lens.
- Hypoallergenic super-soft face foam.
- Durable anti-slip strap.
- Tear-off and roll-off compatible (sold separately).

447899 · One size
White (01), Yellow (10), Black (90)



GLOVES

NEW X-RACE GLOVES

- Air mesh panels for ventilation and mobility.
- Double Clarino[®] layer at palm and thumb for extra durability and comfort.
- Pre-curved design.
- Silicone fingertip for better grip.
- Direct-injection details on back hand.
- Hook-and-loop wrist closure system.

Air Mesh, Spandex, Clarino[®]

MEN'S

446306
XS, S, M, L, XL, 2XL
Red (30), Blue (80)



LADIES'

446311
S, M, L, XL, 2XL
Turquoise (Aqua) (76),
Black (90)



NEW ADVENTURE TEAM GLOVES

- Spandex construction for flexibility.
- Chamude palm.
- Pre-curved design.
- Non-fading sublimated graphics.
- Slip-on gloves.
- Welded logo.
- Silicon print at inner fingers.

Shell: Spandex, Chamude, Polyester
446305 · S, M, L, XL, 2XL, 3XL
Red (30)



BAGS

CAN-AM SLAYER GEAR BAG BY OGIO

- Large main compartment with easy access to all gear.
- Large separated boot pocket.
- Zippered accessory pocket.
- Easy grab handles for transport.
- Detachable shoulder strap.
- Heavy-duty reinforced base
- Dimensions: 32" H x 16" W x 18" D (81 cm x 41 cm x 46 cm)

100% Polyester

469294 · One size · Black (90)



CAN-AM URBAN BACKPACK BY OGIO

- Airport security friendly protective laptop compartment.
- Padded iPad[™]/tablet/e-reader pocket.
- Dual side water bottle/accessory holders.
- Fully adjustable ergonomic shoulder straps.
- Front pocket with two padded accessory compartments and slip pocket.
- Dimensions: 19.5" H x 13.5" W x 9.5" D (50 cm x 34 cm x 24 cm).

100% Polyester

469293 · One size · Black (90)



JUNIOR

JUNIOR X CRUSH HELMET

- Advanced Plastic Composite Shell.
- Multi-density EPS liner.
- Ultra-plush removable/washable liners.
- Adjustable visor to protect from the elements.
- Multiple air vents help keep you cool and dry.
- Lightweight double-D chin strap.
- Ski-Doo and Can-Am stickers in the box.
- Optional breath deflector (sold separately).

Shell: ABS

448506 · S, M, L · Black with graphics (94)



CAN-AM JUNIOR TRAIL GOGGLES BY SCOTT

- Integrated custom painted frame and strap graphics.
- No Fog[®] anti-fog lens treatment.
- 100% plastic UV protected clear Lexan[®] lens.
- Multi-layer face foam.
- Durable anti-slip strap.

448512 · One size · Black (90)



SIZING CHART

HOW TO MEASURE

- For best results, have someone else take measurements.
- Measure body in underwear.
- Tape must be snug but not tight.
- If measurements fall between two sizes, order the larger size.

- HEAD** Around your head, from the center of the forehead, above the ears and over the natural bump at the back of the head.
- ARM LENGTH** Let the hands hang down on the side in a slightly bent position. Measure from the center of the back of your neck, along the length of your arm, to the wrist.
- CHEST/ BUST** Measure under your arms, around the fullest part of your chest.
- WAIST** Measure around your natural waistline, keeping one finger between the tape and body.
- HIPS** Across the fullest part of the seat.
- INSEAM** Without shoes, from crotch to the floor.

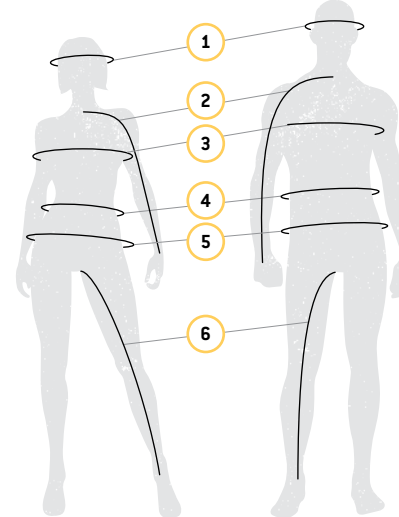

WHAT CODE REPRESENTS YOUR SIZE?

1. Find your size.
2. The corresponding code is **THE CODE** you use to complete the part number on your order.
Example: 440227__90 Size: M = Code "06", therefore 4402270690

SIZE	CODE	SIZE	CODE	SIZE	CODE	SIZE	CODE	SIZE	CODE	SIZE	CODE
One Size	00	XL	12	L/XL	73	11/12	56	10	30	32	38
XS	02	XLT	13	2	21	13/14	80	10.5	99	34	39
XS/S	90	2XL	14	3/4	79	14/16	50	11	31	36	40
S	04	3XL	16	5/6	52	4	23	12	32	38	41
M	06	4XL	18	6/8	48	6	25	13	33	40	42
MT	07	5XL	88	7/8	54	7	27	14	34	42	43
L	09	S/M	72	9/10	55	8	28	28	36	44	44
LT	10	M/L	91	10/12	49	9	29	30	37		

MEN'S—1.77 M - 1.83 M							
	XS	S	M	L	XL	2XL	3XL
CHEST	89-94	94-102	102-112	112-122	122-132	132-142	52-56
WAIST	74-79	79-86	86-97	97-107	107-117	117-127	46-50
HIPS	89-94	94-102	102-112	112-122	122-132	132-142	52-56
ARM LENGTH	79-81	81-84	84-86	86-89	89	89-91	35
INSEAM	80-81	81	81	81	81-82	82-83	32 1/2

LADIES'—1.64 M - 1.77 M							
	XS	S	M	L	XL	2XL	3XL
CHEST	81-86	86-91	91-99	99-107	107-114	114-124	124-134
WAIST	61-66	66-71	71-76	76-86	86-94	94-104	104-114
HIPS	86-91	91-97	97-102	102-112	112-119	119-132	132-140
ARM LENGTH	79	79-81	81	81-83	83	83-86	86
INSEAM	76	76	76	76	76	76-77	77

MEN'S GLOVES (MEASURE PALM WIDTH)						
	S	M	L	XL	2XL	3XL
CM	7.5	8.5	9.5	10.5	11.5	14

LADIES' GLOVES (MEASURE PALM WIDTH)					
	S	M	L	XL	2XL
CM	6.8	7.5	8.3	9	11.5

HELMETS							
	XS	S	M	L	XL	2XL	3XL
HEAD (CM)	53-54	55-56	57-58	59-60	61-62	65-66	65-66

JUNIOR HELMETS			
	S	M	L
HEAD (CM)	49-50	51-52	53-54

GENUINE CAN-AM PARTS

REMEMBER WHAT MADE YOU FALL FOR A CAN-AM VEHICLE?
Precisely engineered. Rigorously tested. Factory approved. The ultimate off-road experience continues with the Genuine Can-Am parts.

PARTS THAT SET THE STANDARD

2 YEARS WARRANTY ON ALL GENUINE CAN-AM PARTS



REGULAR MAINTENANCE ENSURES YOUR MAVERICK SPORT PERFORMANCE STAYS AT ITS PEAK.

KEEP AN EYE ON THESE COMPONENTS*

- | | | |
|-------------------------------|-----------------------------|------------------------------------|
| 1 OIL FILTER 420256188 | 6 DRIVE BELT 422280654 | 11 BALL JOINTS 706202044/706202045 |
| 2 ENGINE OIL SEE P.70 | 7 BRAKE PADS SEE P.66 | 12 SPARK PLUG 707000246 |
| 3 FUEL FILTER 709000330 | 8 BOOT KITS SEE P.66 | 13 BATTERY 410301203 |
| 4 AIR FILTER 715900394 | 9 WHEEL BEARINGS 293350118 | |
| 5 CVT INTAKE FILTER 706600281 | 10 A-ARM BUSHINGS 703500875 | |

*Refer to periodic maintenance chart for proper intervals.

Some products shown may not be available or homologated in your country. Contact your BRP dealer for local details.

REGULAR MAINTENANCE ENSURES YOUR MAVERICK TRAIL PERFORMANCE STAYS AT ITS PEAK.



KEEP AN EYE ON THESE COMPONENTS*

- | | | |
|-------------------------------|-----------------------------|------------------------------------|
| 1 OIL FILTER 420256188 | 6 DRIVE BELT 422280654 | 11 BALL JOINTS 706203084/706202045 |
| 2 ENGINE OIL SEE P.70 | 7 BRAKE PADS SEE P.66 | 12 SPARK PLUG 707000246 |
| 3 FUEL FILTER 709000330 | 8 BOOT KITS SEE P.66 | 13 BATTERY 410301203 |
| 4 AIR FILTER 715900394 | 9 WHEEL BEARINGS 293350118 | |
| 5 CVT INTAKE FILTER 706600281 | 10 A-ARM BUSHINGS 703500875 | |

*Refer to periodic maintenance chart for proper intervals.

GENUINE CAN-AM MAINTENANCE PARTS

OIL FILTER
420256188



O-RING (DRAIN PLUG)
(Not illustrated)
420552280

O-RING (OIL FILTER COVER)
(Not illustrated)
420230920

COMPLETE OIL CHANGE KIT ALSO AVAILABLE—SEE PAGE 72

PREMIUM AIR FILTERS
• The best filter on the market, it prevents airborne contaminants from reaching your engine.
• Protect internal components against premature wear.
• Genuine BRP air filters ensure absolute compatibility and a perfect fit.
715900394

PERFORMANCE AIR FILTER BY TWIN AIR
• The best choice for the harshest conditions.
• Multiple staged oiled filtering foam for superior dust retaining capacity with high air flow.
• Washable and reusable.
715002895



CVT AIR FILTER
(Not illustrated)
706600281

SPARK PLUG
707000246



FUEL PRE FILTER
(Not illustrated)
270600113

FUEL FILTER
(Not illustrated)
709000330
EVAP models only
709000100

FUEL AIR BREATHER FILTER
(Not illustrated)
709000524

VISIT THE CAN-AMOFFROAD.COM PARTS & MAINTENANCE SECTION TO SEE THE FULL LINE OF GENUINE CAN-AM PARTS.

Note: Please contact your dealer or visit our online store at can-amoffroad.com for suggested retail prices regarding Genuine Can-Am Parts.

PREMIUM DRIVE BELT

- High-performance design ideal for off-road use.
- BRP-specific calibration adjusted to best suit your Can-Am vehicle.

422280654



CVT GASKET COVER

(Not illustrated)
420450400

DRIVEN PULLEY EXTRACTOR

529036352 • Maverick Trail
529036352 • Maverick Sport

DRIVEN PULLEY ADAPTOR

708200686 • Maverick Trail
708200686 • Maverick Sport

CV BOOT KITS

- Come with clamps and grease.
- Genuine BRP CV Boot Kits ensure absolute compatibility and a perfect fit.

Front Wheel Side

705401354 • Maverick Sport (ABS, X xc, X mr, X rc models only)
705401345 • Maverick Sport (NO ABS), Maverick Trail

Front Differential Side

705401355 • Maverick Trail, Maverick Sport
Rear
705501864 • Maverick Trail, Maverick Sport



A-ARM BUSHING KIT

- This bushing kit includes 2 bushings, a sleeve and a wearplate, as illustrated. All you need to renew your suspension A-Arms

703500875



Note: Please contact your dealer or visit our online store at can-amoffroad.com for suggested retail prices regarding Genuine Can-Am Parts.

Some products shown may not be available or homologated in your country. Contact your BRP dealer for local details.

METALLIC BRAKE PAD KIT

- Built strong to last long – heavy-duty construction stands up to hard braking.
- Designed to handle demanding riding conditions with challenging braking environments such as mud and dunes.
- Created specifically for use with Can-Am vehicles.

715900379 • Front Left
715900386 • Rear Left

715900380 • Front Right
715900387 • Rear Right

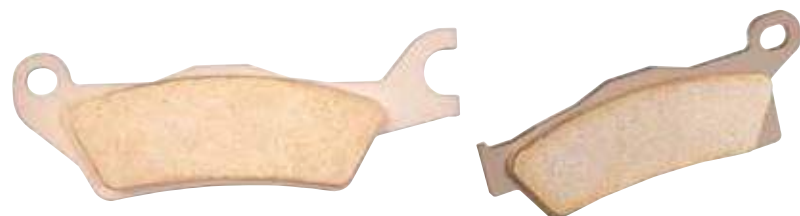

YUASA[†] BATTERIES

- Top of the line models from the leading preferred original equipment battery supplier in North America.

18 Amps. Wet • (YTX20L-BS)
410301203



30 AH BATTERY UPGRADE

- Requires 30ah Battery Holder (715004431).
- Please refer to your user manual for removal and installation.

515176151

PREMIUM HALF SHAFT

- Premium quality design ideal for off-road, heavy-duty and low speed torque usage.
- Includes CVs, Shaft and Boots with the best suited geometry for your Can-Am vehicle.

Models	Front Left	Front Right	Rear
Maverick SPORT (ABS models)	705402443	705402443	705502756
Maverick SPORT BASE, DPS	705402031	705402030	705502552
Maverick TRAIL (All models)	705402008	705402007	705502541



WHEEL BEARINGS

- (Not illustrated)
- Sealed bearings for additional protection from water and dirt.

293350118

BALL JOINTS

- Robust design for off-road usage and sealed for prolonged durability.

706202044 • Upper
706202045 • Lower



CHOOSING THE RIGHT DRIVE BELT CAN IMPACT POWER & PERFORMANCE

WHAT MAKES CAN-AM BELTS STAND OUT?

One essential material stands among our drive belt components: **PBO Fiber**.

PBO Fiber is the next generation super fiber with excellent thermal stability, great abrasion resistance, and moreover, almost twice the strength and modulus of Aramid fiber.

- > We partner with the best manufacturers in the powersports industry to offer you **unique drive belts** with consistent quality.
- > The **100% cutting-edge PBO high-tensile strength polymer fiber** construction offers high-temperature robustness and prolonged durability.

- > Our engineering teams have perfectly integrated and tested each drive belt to **provide quick throttle response, powerful acceleration, top speed and consistent shifting performance.**
- > We aim at delivering the highest levels of performance and longevity based on **your vehicle's specific end-use and calibration.**

CAN-AM BELT CONSTRUCTION VS. COMPETITORS

MODULUS & TENSILE STRENGTH

Based on Dynamometer testing, PBO surpasses Kevlar and Carbon Fiber materials in every way.

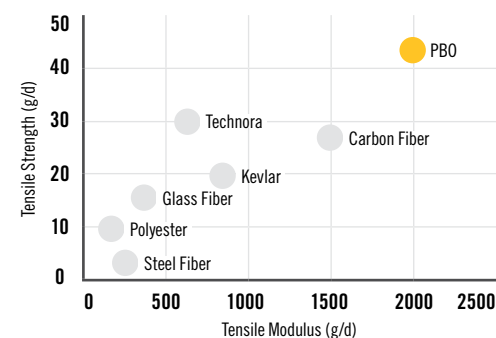

DURABILITY COMPARISON

Compared to Can-Am's Performance Drive Belt (100% PBO - 422280364).

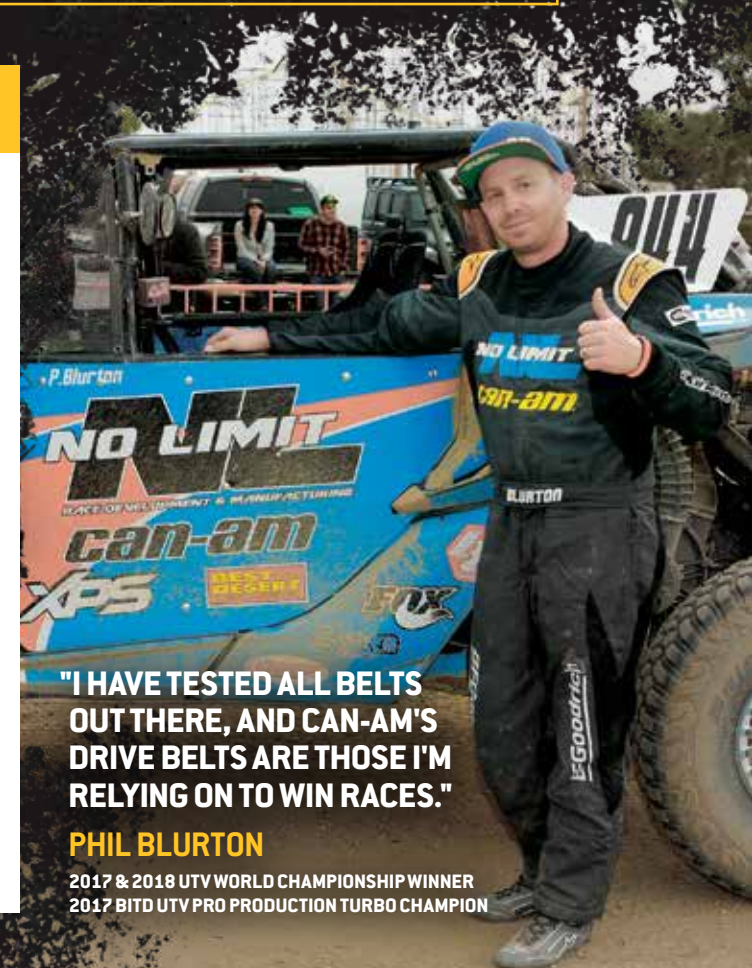
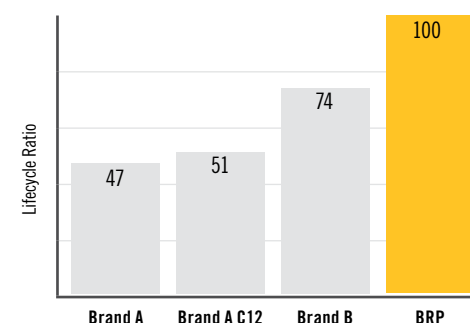

"I HAVE TESTED ALL BELTS OUT THERE, AND CAN-AM'S DRIVE BELTS ARE THOSE I'M RELYING ON TO WIN RACES."

PHIL BLURTON

2017 & 2018 UTV WORLD CHAMPIONSHIP WINNER
2017 BITD UTV PRO PRODUCTION TURBO CHAMPION



Rotax ACE triple-cylinder engine



Rotax V-twin engine



KYLE CHANEY
2017 TORC PRO MOD UTV CHAMPION



PHIL BLURTON
2017 BITD UTV PRO PRODUCTION
TURBO CHAMPION

WHY XPS OIL IS THE PERFECT FIT FOR YOUR ROTAX ENGINE?

Whether you purchased it as a necessity for transportation, or the pure exhilaration of performance, your Can-Am is an investment – get the most out of it. XPS lubricants are the only lubricants specifically engineered to do that with your Rotax-powered Can-Am vehicles.

XPS oil meets the demands of high-performance off-road engines, including turbo and supercharged engines. XPS oil is formulated specifically for the higher stress these engines experience.

UNMATCHED RELIABILITY

Get the most out of every mile on every ride.

ULTIMATE PERFORMANCE

Engineered to match the advanced performance of Rotax Engines.

MADE FOR THIS

Developed with Rotax engines to deliver the best performance and lubrication in all conditions.

XPS OIL HAS UNDERGONE RIGOROUS TESTING IN WORST CASE SCENARIOS TO PROVE ITSELF AND WILL BE USED BY MANY CAN-AM OFF-ROAD RACERS THIS YEAR.



VISIT THE CAN-AMOFFROAD.COM PARTS & MAINTENANCE SECTION TO SEE THE FULL LINE OF XPS LUBRICANTS.

XPS IS A COMPLETE RANGE OF PERFORMANCE PRODUCTS DESIGNED TO PROTECT YOUR VEHICLE AND EXTEND ITS LIFETIME.

EACH HAS BEEN RIGOROUSLY DEVELOPED, TESTED AND APPROVED. TAKE THE GUESSWORK OUT OF YOUR VEHICLE MAINTENANCE AND GET TRUE XPS PEACE OF MIND.



XPS ENGINE OILS

NEW 4T 10W-50 SYNTHETIC OIL

- Engineered for heavy-duty and high-performance 4-stroke engines, including turbocharged, supercharged and racing engines.
- Formulated using carefully selected and strenuously tested base stocks and custom additives.
- Offers thick film strength to protect bearings, and a proven high-temp detergency to minimize deposits, prevent shear, provide thermal stability, and combat fuel dilution to ensure maximum performance from your engine.

946 ml
779234
3.785 L
779235



4T 0W-40 SYNTHETIC OIL

- 4-stroke engines powering recreational vehicles through mud, snow and water withstand a lot of high RPM and high load abuse, and this full synthetic oil is carefully engineered to provide the best protection for high-performance ATVs and SSVs.
- Its wide operating temperature range, additional corrosion protection, and engineered detergency make this oil the best choice for any powersport vehicle with a 4-stroke engine used in cold weather.

946 ml
779139
3.785 L
779140



4T 5W-40 SYNTHETIC BLEND OIL

- This synthetic blend is the oil of choice for owners of high-performance vehicles with a 4-stroke engine, including turbo or supercharged engines requiring carefully engineered friction.
- Combining the finest quality synthetic base stocks with extreme-tested synthetic additives, it provides superior engine and transmission protection against rust and corrosion compared to conventional engine oils, and optimum wet clutch operation for smooth and positive shifting with better cold start protection than 10W oils.

946 ml
779133
3.785 L
779134



LUBRICANTS

SYNTHETIC GEAR OIL

- Uses custom additives to provide the best performance in Visco-Lok & Smart-Lok differentials.
- Allows higher loads, superior shear stability and reduced oxidation.
- Exceptional wear protection and superior performance at all operating temperatures.

• 946 ml
779158
75W-90

779160
75W-140



SYNTHETIC GREASE SUSPENSION

- Designed to work specifically with the components found in Can-Am vehicle suspensions.
- It is highly stable and offers optimal lubrication at both extreme cold and high temperatures while protecting suspension components from dirt and moisture, as well as corrosion under extreme washout conditions.

• 400 g
779163



ANTI-CORROSIVE LUBRICANT

- Multipurpose lubricant that can also be used to prevent rust, corrosion and moisture intrusion.
- It contains extreme pressure additives that work as an all-around lubricant for just about anywhere lubrication is needed.

• 340 g
779168



EXTENDED LIFE PRE-MIXED COOLANT

- XPS Antifreeze/Coolant contains the correct dilution and the necessary additives to prevent corrosion and inhibit cavitation in BRP cooling systems.
- Long-life, 5-year formula specially formulated for BRP vehicles.
- Superior heat transfer.
- Ideal replacement for vehicles that normally use a 2-year antifreeze/coolant (green), 5-year (orange).

• 946 ml
779150



Note: Please contact your dealer or visit our online store at can-amoffroad.com for suggested retail prices of XPS products. Some products shown may not be available or homologated in your country. Contact your BRP dealer for local details.

Note: Please contact your dealer or visit our online store at can-amoffroad.com for suggested retail prices of XPS products.

XPS MAINTENANCE PRODUCTS

DOT4 BRAKE FLUID

- Meets or exceeds all DOT3 and DOT4 brake fluid requirements.
- High-temperature formula resists fade, and also conditions seals and o-rings in braking system.

• 355 ml

779151



RACING BRAKE FLUID

- Exceeds DOT4 brake fluid requirements for extreme conditions and competition use.
- Extreme, 579-degree boiling point temperature is ideal for high-demand competition conditions to combat brake fade.

• 355 ml

779152



ENGINE OIL CHANGE KIT

- Ultra-convenient "all-in-one" oil change kit saves time and money.
- Includes XPS Synthetic or Synthetic Blend Oil, oil filter, o-rings and washer.

779256 • Synthetic Blend (5W-40 450 CC or less)

779257 • Full Synthetic (0W-40 450 CC or less)

779258 • Synthetic Blend (5W-40 500 CC or more)

779259 • Full Synthetic (0W-40 500 CC or more)

779252 • Full Synthetic (10W-50 500 CC or more)

779260 • Synthetic Blend (5W-40 900 ACE)

779261 • Full Synthetic (10W-50 900 ACE)



HIGH PERFORMANCE SUSPENSION FLUID

- A synthetic, fade-free formula for servicing FOX® shocks.
- Specially formulated for high-demand or racing application.
- Ultra high VI shock oil.
- Engineered viscosity for optimized performance with FOX® shocks valving.

• 946 ml

779153



CARBON FREE FUEL TREATMENT

- Combination of a fuel treatment and a fuel system cleaner that can be used periodically to restore lost starting or throttle performance, as well as maintain fuel system integrity and keep internal engine parts clean.
- It treats fuel for storage and addresses the moisture problems inherent in today's Ethanol-blended fuels, keeping ferrous and soft metal parts clean and free of corrosion.
- Uses patented, state-of-the-art additives.
- Cleans valves, sticky rings and combustion chamber.

• 355 ml

779169



FUEL TREATMENT CARBURETOR CLEANER

- Complete fuel treatment specially formulated to prevent small engine problems caused by Ethanol-blended fuels.
- It removes fuel system gum and varnish that may have accumulated during storage, stabilizes fuel against breakdown for 12 months or more, and adds corrosion protection from moisture for short- and long-term storage.
- It also helps restore throttle response and easy starting.
- It can be used periodically to maintain fuel system integrity, keep carburetor jets clean, and also combat moisture problems caused by Ethanol-blended fuels to keep ferrous and soft metal parts clean and free of corrosion.

• 355 ml

779172



FUEL STABILIZER

- Ethanol-compatible and will stabilize fuel in your tank to keep it from breaking down and causing hard starting, throttle hesitation and poor run quality.
- Ethanol attracts moisture, and this product contains powerful anti-corrosion additives to protect fuel system components.
- Prevents problems associated with E10 fuels.

• 236 ml

779171



XPS CLEANERS

SPRAY CLEANER & POLISH

- Removes dirt, grease, road grime and water marks easily and quickly.
- Non petroleum based formula will not harm plastic finishes.

• 340 g

219702844



BRAKES & PARTS CLEANER

- A concentrated blend of solvents with a powerful blasting spray that effectively removes grease, grime, brake fluid and other contaminants from brake components and metal parts without the need for disassembly.
- Evaporates instantly and completely, leaving no residue to hinder performance.
- Contains no ozone depleters.

• 397 g

219701776



OFF-ROAD VEHICLE WASH

- A biodegradable non-toxic cleaner that removes mud and dried-on dirt from your off-road vehicle.
- Whether grimy from the track, the woods or the fields, this cleaner will leave your off-road vehicle sparkling.
- When used as directed, XPS Wash is safe for all off-road vehicle finishes.

• 946 ml

219701702



MICROFIBER TOWELS

- The latest in high-quality detailing towels.
- Made up of extremely fine fibers, their soft surfaces have been perfected for drying and polishing painted, gel coated and hard shiny surfaces.
- They are so absorbent they hold up to seven times their weight in water.
- Machine washable means they can be used over and over again.

• Pack of 2.

219701759



ski-doo LYNX SEA-DOO EVINRUDE ROTAX Can-am

Note: Please contact your dealer or visit our online store at can-amoffroad.com for suggested retail prices of XPS products.

Some products shown may not be available or homologated in your country. Contact your BRP dealer for local details.